

Wilo-Control EC-Rain EC-rf

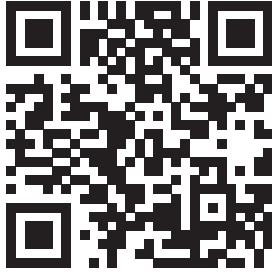

en Installation and operating instructions



RainSystem AF 150
<https://qr.wilo.com/533>

Table of contents

1 General	4	10 Maintenance	46
1.1 About these instructions	4	10.1 Maintenance intervals.....	46
1.2 Copyright	4	10.2 Maintenance tasks.....	46
1.3 Subject to change.....	4	11 Faults, causes and remedies	46
1.4 Exclusion from warranty and liability.....	4	11.1 Operator responsibilities	47
2 Safety	4	11.2 Fault indication	47
2.1 Identification of safety instructions	4	11.3 Fault acknowledgement.....	47
2.2 Personnel qualifications.....	5	11.4 Fault memory	47
2.3 Electrical work	5	11.5 Error codes.....	47
2.4 Monitoring devices	5	11.6 Further steps for troubleshooting.....	48
2.5 Installing/dismantling.....	5	12 Disposal	48
2.6 During operation.....	5	12.1 Information on the collection of used electrical and elec- tronic products.....	48
2.7 Maintenance tasks.....	5	13 Appendix	49
2.8 Operator responsibilities	6	13.1 System impedances	49
3 Application/use	6	13.2 Overview of the symbols.....	50
3.1 Intended use.....	6	13.3 Overview of terminal diagrams.....	51
3.2 Improper use.....	6	13.4 ModBus: Data types.....	52
4 Product description	6	13.5 ModBus: Parameter overview	52
4.1 Structure	6	13.6 Connection of feeding pump(s)	54
4.2 Functional principle	6		
4.3 Technical data	7		
4.4 Inputs and outputs	7		
4.5 Type key.....	8		
4.6 Operation on electronic start-up controllers	8		
4.7 Installation in potentially explosive atmospheres	8		
4.8 Scope of delivery.....	8		
4.9 Accessories	8		
5 Transportation and storage	8		
5.1 Delivery.....	8		
5.2 Transport.....	9		
5.3 Storage	9		
6 Installation	9		
6.1 Personnel qualifications.....	9		
6.2 Installation types	9		
6.3 Operator responsibilities	9		
6.4 Installation	9		
6.5 Electrical connection.....	10		
7 Operation	17		
7.1 Functional principle.....	18		
7.2 Menu control	22		
7.3 Menu type: Main menu or Easy Actions menu.....	22		
7.4 Call up the menu	22		
7.5 Quick access to “Easy Actions”	22		
7.6 Factory settings	23		
8 Commissioning	23		
8.1 Operator responsibilities	23		
8.2 Activating the switchgear	23		
8.3 Start initial configuration.....	24		
8.4 Start automatic mode	39		
8.5 During operation.....	40		
9 Shut-down	45		
9.1 Personnel qualifications.....	45		
9.2 Operator responsibilities	45		
9.3 Shut-down.....	45		
9.4 Removal.....	45		

1 General

1.1 About these instructions

These instructions form part of the product. Compliance with the instructions is essential for correct handling and use:

- Read the instructions carefully before all activities.
- Keep the instructions in an accessible place at all times.
- Observe all product specifications.
- Observe the markings on the product.

The language of the original operating instructions is German. All other languages of these instructions are translations of the original operating instructions.

1.2 Copyright

WILO SE © 2025

The reproduction, distribution and utilisation of this document in addition to communication of its contents to others without express consent is prohibited. Offenders will be held liable for payment of damages. All rights reserved.

1.3 Subject to change

Wilo shall reserve the right to change the listed data without notice and shall not be liable for technical inaccuracies and/or omissions. The illustrations used may differ from the original and are intended as an exemplary representation of the product.

1.4 Exclusion from warranty and liability

Wilo shall specifically not assume any warranty or liability in the following cases:

- Inadequate configuration due to inadequate or incorrect instructions by the operator or the client
- Non-compliance with these instructions
- Improper use
- Incorrect storage or transport
- Incorrect installation or dismantling
- Insufficient maintenance
- Unauthorised repairs
- Inadequate construction site
- Chemical, electrical or electrochemical influences
- Wear

2 Safety

This chapter contains basic information for the individual phases of the life cycle. Failure to observe this information carries the following risks:

- Risk of personal injury from electrical, electromagnetic or mechanical influences
- Environmental damage from discharge of hazardous substances
- Damage to property
- Failure of important functions

Failure to observe the information contained herein will result in the loss of claims for damages.

The instructions and safety instructions in the other chapters must also be observed!

2.1 Identification of safety instructions

These installation and operating instructions set out safety instructions for preventing personal injury and damage to property, which are displayed in different ways:

- Safety instructions relating to personal injury start with a signal word and are **preceded by a corresponding symbol**.



DANGER

Type and source of the danger!

Consequences of the danger and instructions for avoidance.

- Safety instructions relating to property damage start with a signal word and are displayed **without** a symbol.

CAUTION

Type and source of the danger!

Consequences or information.

Signal words

- **Danger!**
Failure to observe safety instructions will result in serious injury or death!
- **Warning!**
Failure to follow instructions can lead to (serious) injury!

- **Caution!**
Failure to follow instructions can lead to property damage and possible total loss.
- **Notice!**
Useful information on handling the product

Markups

- ✓ Prerequisite
- 1. Work step/list
 - ⇒ Notice/instructions
 - ▶ Result

Symbols

These instructions use the following symbols:



Danger of electric voltage



Danger – explosive atmosphere



Useful information

- | | | |
|------------|---------------------------------|---|
| 2.2 | Personnel qualifications | <ul style="list-style-type: none"> • Personnel have been instructed on locally applicable regulations governing accident prevention. • Personnel have read and understood the installation and operating instructions. • Electrical work: qualified electrician
Person with appropriate technical training, knowledge and experience who can identify and prevent electrical hazards. • Installation/dismantling work: qualified electrician
Knowledge regarding tools and fixation material for various structures • Operation/control: Operating personnel, instructed in the functioning of the complete system |
| 2.3 | Electrical work | <ul style="list-style-type: none"> • Electrical work must be carried out by a qualified electrician. • Before commencing work, disconnect the product from the mains and safeguard it from being switched on again. • Observe applicable local regulations when connecting to the mains power supply. • Adhere to the requirements of the local energy supply company. • Earth the product. • Observe technical information. • Replace a defective connection cable immediately. |
| 2.4 | Monitoring devices | <p>Circuit breakers/Fuses</p> <p>The size and switching characteristics of the circuit breakers/fuses must conform to the rated current of the connected consumer. Observe local regulations.</p> |
| 2.5 | Installing/dismantling | <ul style="list-style-type: none"> • Observe the laws and regulations on workplace safety and accident prevention in force at the site. • Disconnect the product from the mains and secure it against being switched on again. • Suitable fixation material must be used for the existing bearing surface. • The product is not watertight. Select an appropriate installation site! • Do not deform the housing during installation. Seals could leak and affect the stated IP rating. • The product may not be installed in potentially explosive areas. |
| 2.6 | During operation | <ul style="list-style-type: none"> • The product is not watertight. Comply with protection class IP54. • Ambient temperature: 0 – 40 °C. • Maximum humidity: 90%, non-condensing. • Do not open the switchgear. • The user must notify the person in charge of every fault or irregularity immediately. • In case of damage to the product or connection cable, switch off the product immediately. |
| 2.7 | Maintenance tasks | <ul style="list-style-type: none"> • Do not use any aggressive cleaners or scouring agents or fluids. • The product is not watertight. Do not submerge the product in fluids. • Only carry out maintenance tasks mentioned in these installation and operating instructions. • Only original parts from the manufacturer may be used for maintenance and repairs. Use of parts other than the original parts releases the manufacturer from any liability. |

2.8 Operator responsibilities

- Provide installation and operating instructions in a language which the personnel can understand.
- Make sure that the personnel has had the corresponding training for the specified work.
- Safety and information signs mounted on the device must always be legible.
- Train the personnel on how the system operates.
- Eliminate risk from electrical current.
- To ensure safe working practice, define personnel responsibilities.

Children and persons younger than 16 years or with reduced physical, sensory or mental capacities or limited experience are prohibited from handling the product! A technician must supervise persons younger than 18 years!

3 Application/use

3.1 Intended use

The switchgear is designed for level- or pressure-dependent control of up to two uncontrolled fixed-speed pumps in rainwater utilisation systems:

- Rainwater utilisation system with 150-litre fresh water tank (AF150)

The signal is acquired by a float switch, fill level sensor or pressure sensor.

Intended use also includes observance of these instructions. Any other use is regarded as improper.

3.2 Improper use

- Installation in potentially explosive atmospheres
- Overflow of the switchgear

4 Product description

4.1 Structure



Fig. 1: Switchgear front

1	Main switch
2	EC-Rain control knob
3	EC-Rain LED display
4	EC-Rain LCD display

The front of the switchgear comprises the following main components:

- Main switch for switching the switchgear on/off
- Control knob for menu selection and parameter input
- LEDs for displaying the current operating state
- LCD display for showing the current operating data and individual menu items

4.2 Functional principle

In principle, the application for rainwater utilisation can be divided into a pressurisation and water supply part with rainwater or fresh water. The control unit can be switched between the EC-rF (AF150) system, rainwater utilisation with fresh water tank, and EC-rh (AF400), rainwater utilisation with hybrid tank.

The EC-rF control unit includes the pressurisation and water supply functions for the AF150.

4.2.1 Pressurisation

The pressure is controlled via a two-position controller. The pumps are automatically switched on and off individually as required depending on the ratio of target pressure to actual pressure in the system.

4.2.2 Water supply

The EC-rF switchgear is used to monitor the fill level of a rainwater storage tank and switch between rainwater or fresh water using a 3-way valve. A separate fresh water tank is used to supply fresh water when rainwater is not available.

4.2.3 All systems

The current operating data and operating conditions are shown on the LCD display and indicated by LEDs. Operation and input of operating parameters is carried out using a rotary knob.

Faults are stored in the fault memory.

4.3 Technical data

Date of manufacture*	See rating plate
Mains connection	See rating plate
Mains frequency	50/60 Hz
Max. current consumption per pump	See type designation
Max. rated power per pump	See rating plate
Pump activation type	See type designation
Ambient/operating temperature	0 – 40 °C
Storage temperature	-30 to +60 °C
Max. relative humidity	90%, non-condensing
Protection class	IP54
Electrical safety	Pollution degree II
Control voltage	See rating plate
Housing material	Steel sheeting, powder coated

Details about the Hardware version (HW) and Software version (SW) can be found on the rating plate!

*The date of manufacture is stated in accordance with ISO 8601: JJJJww

- JJJJ = year
- W = abbreviation for week
- ww = calendar week

4.4 Inputs and outputs

Inputs	Number of inputs
	EC-Rain 1P – 2P (EC-rF)
Pressure detection for pressure control	
Passive pressure sensor 4 to 20 mA	1
Level measurement for water supply	
Passive filling level sensor of rainwater storage tank 4–20 mA	1
Passive filling level sensor of tank 4–20 mA	–
Level sensor with 6 reed contacts (S0–S5)	–
Optional float switch	
Dry-run float switch of rainwater storage tank	1
Pressure switching, pressure output side	1
Return float switch of rainwater storage tank	1
Overflow float switch of tank	1
Pump monitoring	
Thermal winding monitor (bimetallic sensor)	1–2
Thermal winding monitor (PTC sensor)	–
Thermal winding monitor (Pt100 sensor)	–
Fault message frequency converter	–
Other inputs	
Extern OFF: for remote deactivation of all pumps	1

Key

1/2 = number of inputs, – = not available

Outputs	Number of outputs
	EC-Rain 1P – 2P (EC-rF)
Collective fault signal (changeover contact)	1
Collective run signal (changeover contact)	1
Time-delayed auxiliary output (normally closed contact (NC))	1-2
Valve contact (normally open contact (NO))	1-2
Dry-running signal (normally closed contact (NC))	1
Power output (connection load: 24 V=, max. 4 VA) E.g. output for connecting an external alarm signal (lamp or horn)	1
Display of actual pressure value (0 – 10 V=)	1
Level measurement display of rainwater storage tank (0 – 10 V=)	1
Level measurement display of tank (0 – 10 V=)	–

Key

1/2 = number of outputs, – = not available

4.5 Type key

Example: Wilo-Control EC-Rain 2x12A-T34-DOL-WM	
EC	Version with Easy Control switchgear: EC = switchgear for fixed-speed pumps
Rain	Control unit for rainwater utilisation systems
2x	Max. number of pumps that can be connected
12A	Max. rated current per pump in amperes
T	Mains connection: M = alternating current (1~) T = three-phase current (3~)
34	Rated voltage: 2 = 220/230 V 34 = 380/400 V
DOL	Pump activation type: DOL = direct on line
WM	Wall fixation

4.6 Operation on electronic start-up controllers

Connect the switchgear directly to the pump and the mains. Intermediate switching of additional electronic start-up controllers, e.g. a frequency converter, is not permitted!

4.7 Installation in potentially explosive atmospheres

The switchgear does not have its own explosion protection class. **Do not** install the switchgear in potentially explosive areas!

4.8 Scope of delivery

- Switchgear
- Installation and operating instructions for Control EC-Rain

4.9 Accessories

- Float switch
- Pressure switch
- Pressure sensor 4 to 20 mA
- Filling level sensor 4-20 mA

5 Transportation and storage**5.1 Delivery**

- After delivery, check product and packaging for defects (damage, completeness).
- Defects must be noted on the freight documentation.
- Defects must be notified to the transport company or the manufacturer on the day of receipt of shipment. Claims cannot be asserted if the notification of defects takes place at a later date.

5.2 Transport

CAUTION

Property damage due to wet packaging!

Wet packaging may tear. If unprotected, the product may fall on the ground and be irreparably damaged.

- Carefully lift wet packaging and replace it immediately.

5.3 Storage

- Clean control device.
- Close housing apertures, ensuring they are sealed watertight.
- Impact-resistant and watertight packaging.
- Pack the switchgear in dustproof and watertight packaging.
- Maintain storage temperature: -30 to +60 °C, max. relative humidity: 90%, non-condensing.
- Frost-proof storage at a temperature of 10 °C to 25 °C with relative humidity of 40 – 50% is recommended.
- Avoid the formation of condensation at all times.
- All open threaded cable glands must be sealed to prevent water ingress into the housing.
- Attached cables should be protected against kinking, damage, and ingress of moisture.
- To prevent damage to the components, protect the switchgear from direct sunlight and heat.
- Clean the switchgear after storage.
- If there has been water ingress or condensation has formed, have all the electronic components tested for correct function. Contact customer service.

6 Installation

6.1 Personnel qualifications

- Check the switchgear for damage caused during transport. Do **not** install defective switchgears!
- Observe the local guidelines for the design and operation of electronic controls.
- Electrical work: qualified electrician
Person with appropriate technical training, knowledge and experience who can identify and prevent electrical hazards.
- Installation/dismantling work: qualified electrician
Knowledge regarding tools and fixation material for various structures

6.2 Installation types

- Installation directly on the rainwater utilisation system
The switchgear is installed directly on the rainwater utilisation system at the factory.
- Wall fixation
If the switchgear needs to be separately installed on a wall, follow the instructions in the "Installation" chapter.

6.3 Operator responsibilities

- The installation location is clean, dry and free of vibration.
- The installation location is overflow-proof.
- The switchgear is not exposed to direct sunlight.
- Installation location outside of potentially explosive atmospheres.

6.4 Installation

- The connection cable and required accessories should be provided by the customer.
- While laying the cable, ensure that there is no tension, no kinking and no pinching that could damage the cable.
- Check the cable cross-section and length for the routing type chosen.
- Seal unused threaded cable glands.
- Ensure that the following ambient conditions are adhered to:
 - Ambient/operating temperature: 0 – 40 °C
 - Relative humidity: 40 – 50%
 - Max. relative humidity: 90%, non-condensing

6.4.1 Basic advice on fixing the switchgear in place

Various structures can be used for installation (concrete wall, mounting rail, etc.). For this reason, the fixation material for the relevant construction must be provided by the customer and the following information must be observed:

- To prevent cracks in the masonry and chipping of the construction material, ensure sufficient clearance to the edge of the structure.
- The depth of the borehole depends on the length of the screws. Drill the borehole approx. 5 mm deeper than the screw length.
- Drilling dust impairs retention force. Always blow the borehole clean or vacuum it out.
- Do not damage the housing during installation.

6.4.2 Installation of switchgear

Screw sizes for metal housing

- Max. screw diameter: 8 mm
- Max. screw head diameter: 12 mm

Installation

Attach the switchgear to the wall with four screws and wall plugs:

- ✓ Switchgear is disconnected from the mains supply and is voltage-free.
- 1. Open the switch cabinet door sideways.
- 2. Align the switchgear on the installation site and mark the position for the drill holes.
- 3. Drill and clean the mounting holes in accordance with the specifications of the fixation material.
- 4. Attach the lower part to the wall with the fixation material.
Check the lower part for deformations! Realign deformed housing (e.g. by placing alignment plates below it) to ensure the switch cabinet door closes securely. **NO-TICE! If the switch cabinet door does not close correctly, the protection class is compromised!**
- 5. Close switch cabinet door.
 - ▶ Switchgear installed. Now connect the mains supply, pumps and signal transmitter.

6.4.3 Low water level (dry-running protection)

The level can be measured via the following signal transmitters:

- Filling level sensor
- Float switch
The float switches must be able to move freely in the operating space (pump chamber, tank)!
- Pressure switch

Regardless of the signal transmitter, all pumps are always **forced switch-off** in the event of an alarm if there is a danger that they could run dry.

6.5 Electrical connection



DANGER

Danger of death due to electrical current!

Improper conduct when carrying out electrical work can lead to death due to electric shock!

- Before all electrical work, disconnect the product from the mains and secure it against being switched on again without authorisation.
- Electrical work must be carried out by a qualified electrician!
- Observe local regulations!



NOTICE

- Depending on the system impedance and the maximum connections/hour of the connected consumers, voltage fluctuations and/or drops may occur.
- When using shielded cables, attach the shielding to the earth rail on one side of the control device.
- Always have connection carried out by a qualified electrician.
- Observe the installation and operating instructions for the connected pumps and signal transmitters.

- The mains connection current and voltage must be as stated on the rating plate.
- Execute fuse protection on the mains side in accordance with the local guidelines.
- If circuit breakers are used, the switching characteristics should be selected according to the connected pump.
- Follow local guidelines if residual-current devices (RCD, type A, sinusoidal current, universal-current-sensitive) are installed.
- Route connection cable in accordance with the local guidelines.
- Do not damage the connection cable during routing or installation.
- Earth the switchgear and all electrical consumers.

6.5.1 Overview of components

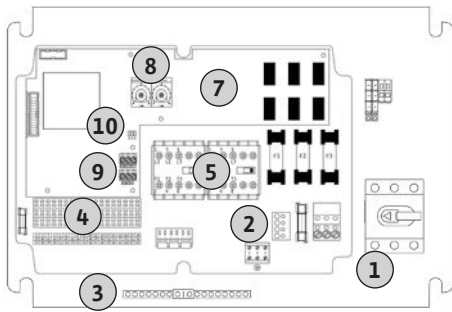

Fig. 2: Control EC-rF

6.5.2 Switchgear mains connection



DANGER

Risk of fatal injury due to electrical current!

Even when the main switch is switched off, there is mains voltage power to the voltage selection terminal.

- Make the voltage selection before connecting the product to the mains.

CAUTION

Risk of property damage due to incorrectly set mains voltage!

An incorrectly set mains voltage will destroy the switchgear. The switchgear can be operated at different mains voltages. The mains voltage is set to 400 V at the factory.

- To select another mains voltage, change the position of the cable jumper before connection.

CAUTION

Risk of property damage due to incorrectly set mains voltage!

If the control voltage is set incorrectly, the control unit will be destroyed. The switchgear can be operated at different mains voltages. The control voltage must always be 230 V.

- The cable jumper is set to the correct control voltage as a factory setting.
- Do not change the cable bridge!

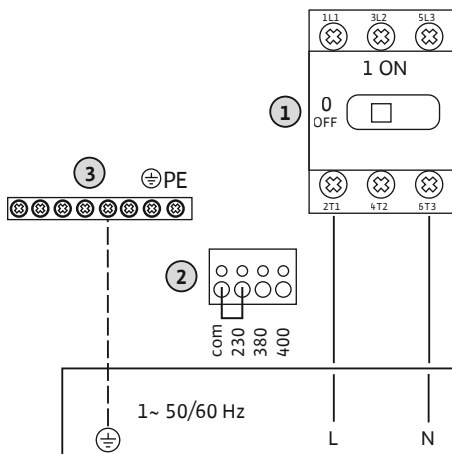

Fig. 3: Mains connection Control EC-rF

1	Terminal strip: Mains connection
2	Mains voltage adjustment
3	Terminal strip: Earth (PE)

Mains connection 1~230 V:

- Cable: 3-core
- Wire: L, N, PE
- Mains voltage adjustment: Converter bridge 230/COM (factory setting)
- Insert the connection cables laid by on-site through the threaded cable glands and secure.
- Connect the wires to the terminal strip according to the connection diagram

6.5.3 Mains connection: Fixed-speed pump

6.5.3.1 Connect pump(s)

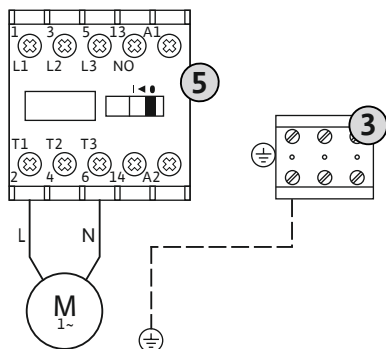

Fig. 4: Pump connection

6.5.3.2 Adjust motor current monitoring

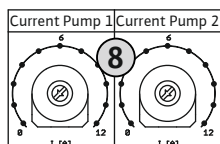

Fig. 5: Set the rated motor current at the potentiometer

6.5.4 Connection, thermal motor monitoring



NOTICE

Power supply and pump connection rotating field

The rotating field is routed from the mains connection directly to the pump connection.

- Check the required rotating field of the pumps to be connected (clockwise or counter-clockwise).
- Observe the installation and operating instructions of the pumps.

3	Terminal strip: Earth (PE)
5	Contactor

Insert the connection cables laid by on-site through the threaded cable glands and secure. Connect the wires to the contactor as per the connection diagram.

NOTICE! After all pumps have been connected, set the motor current monitoring!

The **minimum and maximum** motor current of the connected pumps is monitored:

- Minimum motor current monitoring
The value is permanently stored in the switchgear: 300 mA or 10% of the set motor current.
NOTICE! Monitoring can be disabled in Menu 5.69.
- Maximum motor current monitoring
Adjust the value in the switchgear.
NOTICE! Monitoring cannot be disabled!

Monitoring of the maximum motor current is carried out via electronic motor current monitoring.

After connecting the pumps, set the rated motor current of the pump.

8	Potentiometer for motor current monitoring
---	--

Use a screwdriver to set the rated motor current at the respective potentiometer.

NOTICE! "0" setting on the potentiometer leads to an error when the pump is activated!

Precise adjustment of motor current monitoring can be performed during commissioning. During commissioning, the set and the actual rated motor current can be shown on the display:

- Currently **set** value of the motor current monitoring (Menu 4.25 – 4.26)
- Currently **measured** operating current of the pump (Menu 4.29 – 4.30)

CAUTION

Property damage due to external voltage!

An external voltage which is applied destroys the component.

- Do not apply external voltage (connect potential-free).

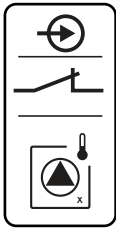

Fig. 6: Connection overview symbol

6.5.5 Connection of pressure sensor

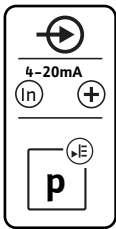

Fig. 7: Connection overview symbol

6.5.6 Connection of optional pressure switch

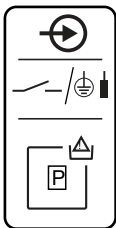

Fig. 8: Connection overview symbol

6.5.7 Connection of level sensor

One thermal motor monitoring device with bimetallic sensors can be connected per pump. Do not connect PTC or Pt100 sensors!

The terminals are fitted with a converter bridge at the factory.

Insert the connection cables (provided by the customer) through the threaded cable glands and secure them. Connect the wires to the terminal strip according to the connection diagram. **Use the terminal number shown in the connection overview on the cover.** The number shown in location "x" on the symbol displays which pump it refers to:

- 1 = pump 1
- 2 = pump 2

CAUTION

Property damage due to external voltage!

An external voltage which is applied destroys the component.

- Do not apply external voltage (connect potential-free).

Pressure detection is performed using an analogue pressure sensor (4 to 20 mA). **NOTICE! Do not attach an active pressure sensor.**

Insert the connection cable laid by the customer through the threaded cable glands and secure. Connect the wires to the terminal strip according to the connection diagram. **Use the terminal number shown in the connection overview on the cover.**

NOTICE! Use shielded connection cables! Apply the shielding on one side!

NOTICE! Observe the correct polarity of the pressure sensor!

CAUTION

Property damage due to external voltage!

An external voltage which is applied destroys the component.

- Do not apply external voltage (connect potential-free).

Pressure detection takes place via a pressure switch.

Insert the connection cable laid by the customer through the threaded cable glands and secure. Connect the wires to the terminal strip according to the connection diagram. **Use the terminal number shown in the connection overview on the cover.**

CAUTION

Property damage due to external voltage!

An external voltage which is applied destroys the component.

- Do not apply external voltage (connect potential-free).

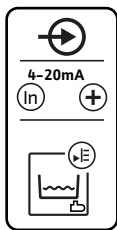

Fig. 9: Connection overview symbol

6.5.8 Connection of optional float switches

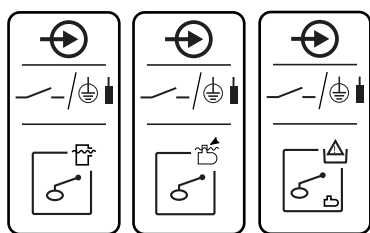

Fig. 10: Connection overview symbol

6.5.9 Collective run signal (SBM) connection

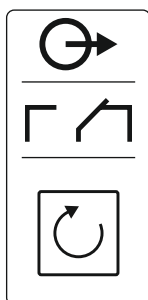

Fig. 11: Connection overview symbol

6.5.10 Collective fault signal connection (SSM)

The filling level of the rainwater storage tank is detected via an analogue filling level sensor 4–20 mA. **NOTICE! Do not connect an active filling level sensor.**

Insert the connection cable laid by the customer through the threaded cable glands and secure. Connect the wires to the terminal strip according to the connection diagram. **Use the terminal number shown in the connection overview on the cover.**

NOTICE! Use shielded connection cables! Apply the shielding on one side!

NOTICE! Observe the correct polarity of the filling level sensor!

CAUTION

Property damage due to external voltage!

An external voltage which is applied destroys the component.

- Do not apply external voltage (connect potential-free).

The water levels for the optional inputs can be detected via additional float switches.

Insert the connection cable laid by the customer through the threaded cable glands and secure. If there are converter bridges, remove them and connect the wires to the terminal strips according to the connection diagram. **Use the terminal number shown in the connection overview on the cover.**

- For a description of how the optional float switch works, see [► 20]



DANGER

Danger of death due to electrical current!

The external electrical power supply is also present at the terminals when the main switch is switched off!

- Disconnect the external power supply before any work.
- Electrical work must be carried out by a qualified electrician.
- Observe local regulations.

A run signal is issued for all pumps (SBM) via a separate output:

- Contact type: potential-free changeover contact
- Contact load:
 - Minimum: 12 V~, 10 mA
 - Maximum: 250 V~, 1 A
- Insert the connection cables laid by the customer through the threaded cable glands and secure.
- Connect the wires to the terminal strip according to the connection diagram.
- Use the terminal number shown in the connection overview on the switchgear cover.



DANGER

Danger of death due to electrical current!

The external electrical power supply is also present at the terminals when the main switch is switched off!

- Disconnect the external power supply before any work.
- Electrical work must be carried out by a qualified electrician.
- Observe local regulations.

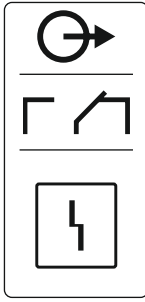

Fig. 12: Connection overview symbol

6.5.11 Connection of dry-running signal (TLS)

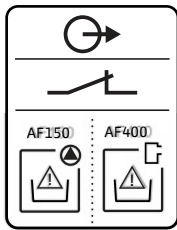

Fig. 13: Connection overview symbol

6.5.12 Valve control connection

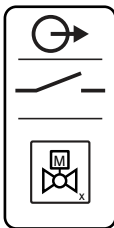

Fig. 14: Connection overview symbol

A fault message is output for all pumps (SSM) via a separate output:

- Contact type: potential-free changeover contact
- Contact load:
 - Minimum: 12 V=, 10 mA
 - Maximum: 250 V~ 1 A
- Insert the connection cables laid by the customer through the threaded cable glands and secure.
- Connect the wires to the terminal strip according to the connection diagram.
- Use the terminal number shown in the connection overview on the switchgear cover.



DANGER

Danger of death due to electrical current!

The external electrical power supply is also present at the terminals when the main switch is switched off!

- Disconnect the external power supply before any work.
- Electrical work must be carried out by a qualified electrician.
- Observe local regulations.

A dry-running signal is issued via a separate output to protect the pressure-boosting pumps from damage.

- Contact type: potential-free NC contact
- Contact load:
 - Minimum: 12 V=, 10 mA
 - Maximum: 250 V~, 1 A

Insert the connection cables (provided by the customer) through the threaded cable glands and secure them. Connect the wires to the terminal strip according to the connection diagram.

Refer to the terminal numbers in the connection overview in the switchgear cover.



DANGER

Danger of death due to electrical current!

The external electrical power supply is also present at the terminals when the main switch is switched off!

- Disconnect the external power supply before any work.
- Electrical work must be carried out by a qualified electrician.
- Observe local regulations.

The 3-way valves are switched via a separate output:

- Contact type: potential-free NO contact
- Contact load:
 - Minimum: 12 V=, 10 mA
 - Maximum: 250 V~, 1 A

Insert the connection cable laid on-site through the threaded cable glands and secure. Connect the wires to the terminal strip according to the connection diagram.

Refer to the terminal numbers in the connection overview in the switchgear cover.

The number shown in location "x" on the symbol displays which pump it refers to:

- 1 = Valve 1
- 2 = Valve 2

6.5.13 Time-delayed auxiliary output

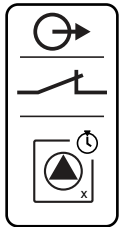

Fig. 15: Connection overview symbol



DANGER

Danger of death due to electrical current!

The external electrical power supply is also present at the terminals when the main switch is switched off!

- Disconnect the external power supply before any work.
- Electrical work must be carried out by a qualified electrician.
- Observe local regulations.

An auxiliary contact with a time delay to the pump is switched via a separate output:

- Contact type: potential-free NC contact
- Contact load:
 - Minimum: 12 V=, 10 mA
 - Maximum: 250 V~, 1 A

The time delay can be set in Menu 5.76.

Insert the connection cables (provided by the customer) through the threaded cable glands and secure them. Connect the wires to the terminal strip according to the connection diagram.

Refer to the terminal numbers in the connection overview in the switchgear cover.

NOTICE! The time-delayed auxiliary output is only switched when the valves are set to rainwater.

The number shown in location “x” on the symbol displays which pump it refers to:

- 1 = auxiliary contact regarding pump 1
- 2 = auxiliary contact regarding pump 2



NOTICE

For the terminal assignment for the optional feeding pumps when using the BE-WP switchgear, see section “Connection of feeding pump” in the Annex.

6.5.14 Connecting an external alarm signal

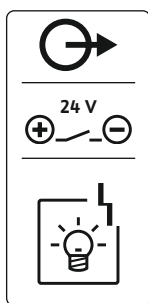

Fig. 16: Connection overview symbol

CAUTION

Property damage due to external voltage!

An external voltage which is applied destroys the component.

- Do not apply external voltage (connect potential-free).

An external alarm signal (horn, flashing light, etc.) can be connected. The output is switched in parallel to the collective fault signal (SSM).

- Alarm signal suitable for DC voltage.
- Connection load: 24 V=, max. 4 VA
- **NOTICE! Observe the correct polarity when connecting!**
- Activate output in menu 5.67.

Insert the connection cables laid by the customer through the threaded cable glands and secure. Connect the wires to the terminal strip according to the connection diagram. **Use the terminal number shown in the connection overview on the cover.**

6.5.15 Connection of an actual pressure value display

CAUTION

Property damage due to external voltage!

An external voltage which is applied destroys the component.

- Do not apply external voltage (connect potential-free).

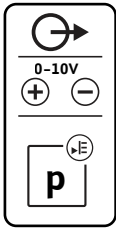

Fig. 17: Connection overview symbol

6.5.16 Connection for actual fill-level value display

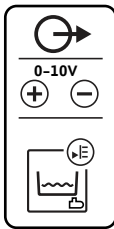

Fig. 18: Connection overview symbol

6.5.17 Connection ModBus RTU



Fig. 19: Jumper position

The actual pressure value is transmitted via a separate output. A voltage of 0 to 10 V= is provided for this at the output:

- 0 V = pressure sensor value “0”
 - 10 V = pressure sensor upper limit
- Example:
- Pressure sensor measurement range: 0 – 16 bar
 - Display range: 0 – 16 bar
 - Setting: 1 V = 1.6 bar

Insert the connection cables (provided by the customer) through the threaded cable glands and secure them. Connect the wires to the terminal strip according to the connection diagram. **Use the terminal number shown in the connection overview on the cover.**

CAUTION

Property damage due to external voltage!

An external voltage which is applied destroys the component.

- Do not apply external voltage (connect potential-free).

The actual fill-level value is transmitted via a separate output. A voltage of 0 to 10 V= is provided for this at the output:

- 0 V = fill level sensor value “0”
 - 10 V = fill level sensor upper limit
- Example:
- Measurement range of filling level sensor: 0 – 5 m
 - Display range: 0 – 5 m
 - Setting: 1 V = 0.5 m

Insert the connection cables (provided by the customer) through the threaded cable glands and secure them. Connect the wires to the terminal strip according to the connection diagram.

Refer to the terminal number in the connection overview in the cover.

CAUTION

Property damage due to external voltage!

An external voltage which is applied destroys the component.

- Do not apply external voltage (connect potential-free).

See Overview of components for position numbers

9	ModBus: RS485 interface
10	ModBus: Jumper for termination/polarisation

The ModBus protocol is available for connection to a building management system.

- Insert the connection cable laid by the customer through the threaded cable glands and secure.
- Connect the wires to the terminal strip according to the connection diagram.

Observe the following points:

- Interface: RS485
- Field bus protocol settings: Menu 2.01 to 2.05.
- The switchgear is terminated at the factory. Remove termination: Remove jumper “J2”.
- If the ModBus requires a polarisation, plug in jumpers “J3” and “J4”.

7 Operation



DANGER

Danger of death due to electrical current!

There is danger of death from open switchgear.

- Only operate the switchgear when closed.
- Electrical work on the internal components must be carried out by a qualified electrician.

7.1 Functional principle

7.1.1 EC-rF (AF150)

Pressurisation

During normal operation, the system maintains a pressure in the range between the activation and deactivation thresholds. A maximum of two pumps can be controlled in this control mode. Control is carried out as two-position control. A pressure sensor measures the actual pressure value. If the pressure falls below the activation threshold, the base-load pump switches on. Depending on the required performance, the peak-load pump is switched on if the activation threshold has fallen below and after the cut-in delay has elapsed. If the deactivation threshold for the peak-load pump is exceeded, the system turns off the peak-load pump after the deactivation delay has elapsed. If the deactivation threshold for the base-load pump is exceeded, the system turns off the base-load pump after the deactivation delay has elapsed.

Water supply

The water supply for the AF150 is provided on the one hand by a rainwater storage tank and on the other hand by a separate 150 litre tank, which is automatically filled with fresh water. The water supply source varies depending on the availability of rainwater and fresh water; a 3-way valve separates the two pipes to prevent mixing. A filling level sensor is used to monitor the current water level in the rainwater storage tank. Thresholds can be set for dry-running, high-water and overflow detection, as well as the thresholds for fresh or rainwater utilisation. For detailed settings of the rainwater storage tank and its level, see Setting parameters and definition of rainwater storage tank [► 19].

The schematic overview of the AF150 rainwater utilisation system and optional float switches are shown in the illustration.

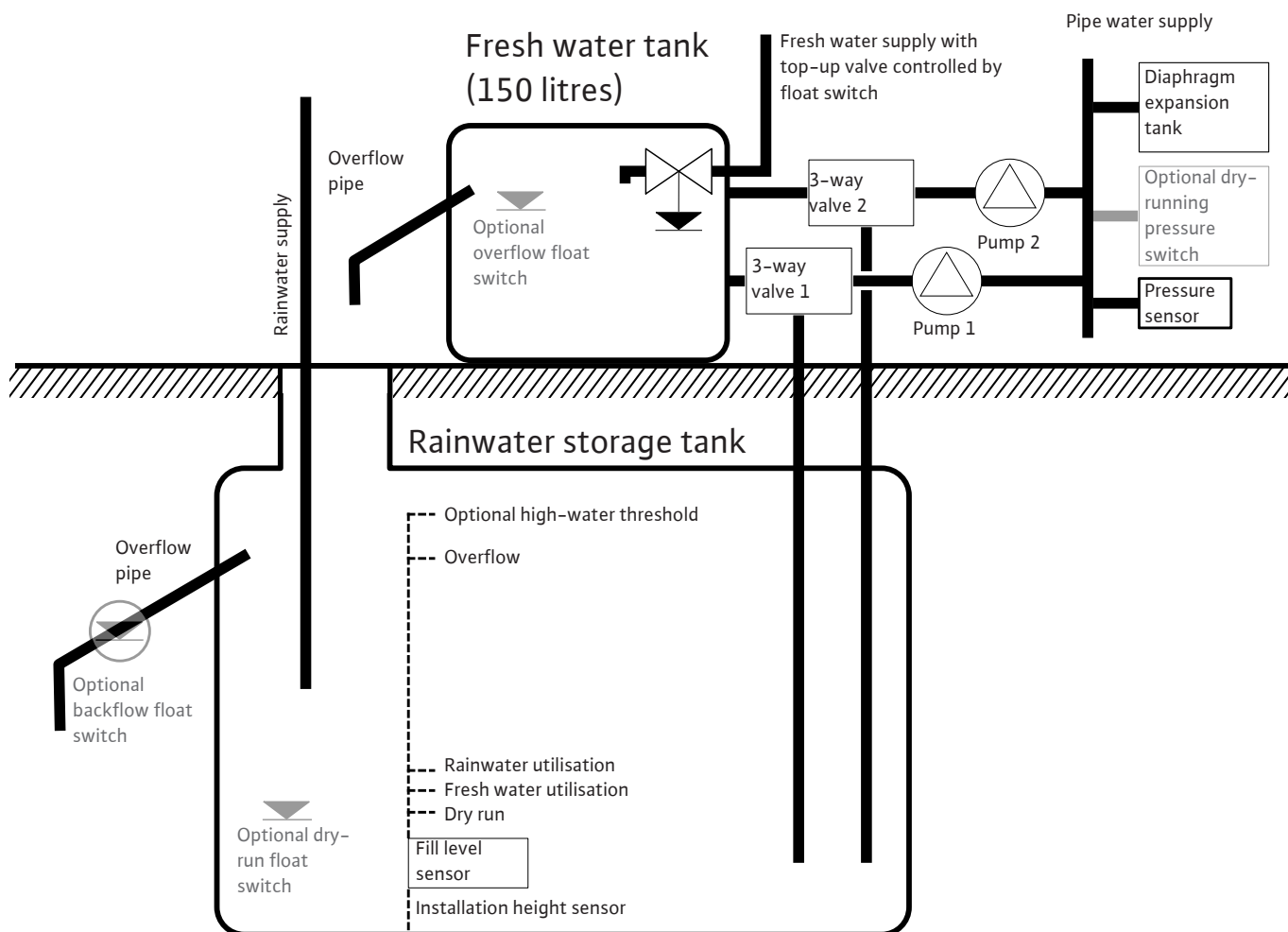

Fig. 20: Functional principle of the AF150 shown schematically

7.1.2 Setting parameters and definition of rainwater storage tank

EC-rF (AF 150)

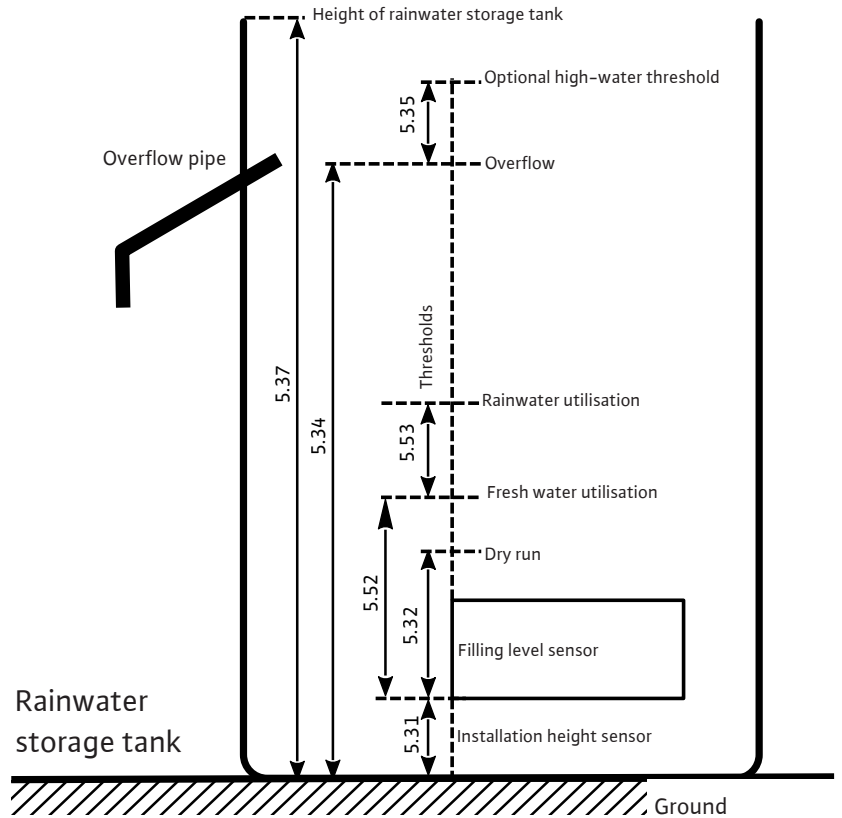

Fig. 21: Setting parameters and menus for the settings

Filling level sensor measurement range	Installation height sensor	Dry-running threshold	Overflow threshold
Optional high-water threshold	Rainwater storage tank height	Fresh water ON	Fresh water OFF / Rainwater ON

Table 1: Required settings in the menu for the rainwater storage tank



NOTICE

The “Δ” symbol in the display means that the default values have a fixed reference to another default value, such as the sensor height.

The fill level of the rainwater storage tank is monitored as standard with a filling level sensor (measurement range of the sensor can be set in Menu 5.30), which has a relative distance from the bottom of the rainwater storage tank (Menu 5.31) to which other setting parameters refer. If the fill level falls below the dry-running threshold that can be set in the rainwater storage tank (Menu 5.32), the EC-rF switchgear switches the 3-way valves to fresh water regardless of the operating status of the pumps. As dry run is a common state in a rainwater storage tank, there is no alarm signal. Only a dry run meter (Menu 4.47) provides information on how often the level has fallen below this level. The position of the 3-way valves is controlled by the EC-rF switchgear using the fill level of the rainwater storage tank. For this purpose, the deactivation thresholds for fresh water and rainwater are defined in Menus 5.52 and 5.53. However, the 3-way valve is only switched to fresh water if the corresponding pump is running, otherwise it is switched back to rainwater. As soon as

the fill level in the rainwater storage tank has exceeded the overflow threshold (Menu 5.34), an overflow meter (Menu 4.48) increases, which serves as information on how often this threshold has already been exceeded. As the overflow of a rainwater storage tank is a desired state for flushing out deposits such as leaves, there is no alarm signal. If the water level nevertheless continues to rise, an alarm is triggered when the high-water threshold (Menu 5.35) is exceeded and the valves are forced to rainwater. This parameter is optional and can be deactivated in the menu.

If a sensor error occurs during operation, the valves are switched to fresh water and the pumps continue to run as required.

As redundancy, there is the option of connecting a float switch for dry-running detection, as well as an optional float switch for detecting backflow into the rainwater storage tank. The description of the optional float switches can be found in section 7.1.3 [► 20].

By default, the current fill level of the rainwater storage tank is displayed in metres on the main screen. To display the current water volume of the rainwater storage tank as a percentage, you must first select the shape of the rainwater storage tank in Menu 5.36, for example for a flat tank. The measurement range 0% – 100% (usable range) extends from the installation height of the sensor in the rainwater storage tank to the overflow. If the water level rises even more, values greater than 100% can be displayed.



NOTICE

The fresh water supply via a tank for the AF150 must be provided and dimensioned by the customer on-site.

7.1.3 Operation with optional float switches

<div style="background-color: #cccccc; padding: 2px; margin-bottom: 5px;">25 26</div>	<div style="background-color: #cccccc; padding: 2px; margin-bottom: 5px;">27 28</div>	<div style="background-color: #cccccc; padding: 2px; margin-bottom: 5px;">29 30</div>	<div style="background-color: #cccccc; padding: 2px; margin-bottom: 5px;">35 36</div>
Pressure switch	Tank overflow threshold	Rainwater storage tank backflow	Dry-running threshold for rainwater storage tank

In addition to operation with filling level sensors, optional float switches can be integrated into the system, which provide redundancy on the one hand and offer additional functional options on the other.

Pressure switch

There is the option of integrating a pressure switch in the pressure output side of the system for the AF150. This provides redundant safety as dry-running protection for the pressure-boosting pumps if a certain pressure is no longer reached. If this contact is opened, the pressure-boosting pumps are deactivated after the set time has elapsed, a dry-running alarm is displayed and the dry-running output is opened. If the contact is closed again, the alarm is reset and the pumps restart if necessary. If the contact is not used, it must be bridged.

Fresh water tank overflow threshold

The fresh water supply for the AF150 must be provided and dimensioned on-site, but it is still possible to integrate a float switch for overflow detection of the fresh water tank. If an overflow is detected, an alarm signal is triggered, but the pumps and valves continue to be switched as required. If the contact is not used, it must be left open.

Rainwater storage tank backflow

To prevent dirt or other suspended matter from flowing back into the rainwater storage tank, which can damage the pumps, there is the option of integrating a float switch in the overflow pipe of the rainwater storage tank, which can detect a backflow. If backflow is detected, the valves are set to fresh water and the pumps are switched as required. An alarm is displayed in the switchgear, which must be acknowledged manually. If the contact is not used, it must be left open.

Dry-running threshold for rainwater storage tank

Analogue to the dry-running threshold in the rainwater storage tank set in Menu 5.32, a float switch can also be integrated, which serves as redundancy on the one hand and enables emergency operation in the event of a sensor error on the other. In Menu 5.10, you must specify how the rainwater storage tank signal is to be acquired.

Both: In “Both” mode, both the filling level sensor and the float switch are used as dry-running detection for the rainwater storage tank. If a sensor error occurs, it is still possible to use rainwater as long as the float switch does not report a dry run.

7.1.4 Minimum and maximum pressure monitoring

Maximum pressure monitoring

The overpressure monitoring is always active, i.e. the pressure in the system is continuously monitored. An alarm is triggered under the following conditions:

- The system pressure rises above the overpressure detection threshold (Menu 5.17, factory setting: 8 bar).
- The delay time for overpressure and underpressure detection has expired (Menu 5.74, factory setting: 5 s).

If the maximum pressure monitoring triggers an alarm, all pumps are deactivated.

The error code is shown on the LCD display and the red LED lights up. The output for the collective fault signal (SSM) is activated.

If the pressure falls below the overpressure detection threshold, the alarm is automatically reset after a short delay.

Minimum pressure monitoring

Minimum pressure monitoring is activated as a factory setting (Menu 5.18, factory setting: 1 bar). As soon as a pump is running, the minimum pressure monitoring is active.

NOTICE! To deactivate the minimum pressure monitoring, set the value in Menu 5.18 to "0 bar".

An alarm is triggered under the following conditions:

- The system pressure falls below the underpressure detection threshold (Menu 5.18, factory setting: 1 bar).
- The delay time for overpressure and underpressure detection has expired (Menu 5.74, factory setting: 5 s).

With underpressure monitoring, the system reaction can be set (Menu 5.73):

- The system continues to operate normally (factory setting: cont). The error code is shown in the LCD display. The alarm is automatically acknowledged with a short delay when the pressure threshold is exceeded.
- The system triggers an alarm (setting: off) and all pumps are deactivated. The error code is shown on the LCD display and the red LED lights up. The output for the collective fault signal (SSM) is activated. The alarm must be acknowledged manually.

7.1.5 Pump cycling

To prevent irregular running times of the individual pumps, the base-load pump is regularly cycled if there are two pumps. When all pumps are switched off, the base-load pump will change the next time the system is activated.

Additionally, repeated pump cycling is activated as a factory setting. This causes the base-load pump to be switched every 6 hours. **NOTICE! To deactivate this function: Menu 5.60!**

7.1.6 Standby pump

With two pumps, one pump can be used as a standby pump. This pump is not activated during normal operation. The standby pump is only activated in the event of pump failure due to a fault. The standby pump is subject to standstill monitoring. The standby pump is therefore activated during pump cycling and pump kick.

7.1.7 Low water level (dry-running protection)

The water level in the rainwater storage tank and the pressure output side (optional) are monitored and sent to the switchgear.

Observe the following points:

- Low water in rainwater storage tank: The valves are set to fresh water operation. There is no error message; only a dry-run meter is increased.
- Dry run on pressure output side: The pressure-boosting pumps are stopped, a dry-running alarm is triggered and the dry-running outlet is opened.
- If the contact is closed again during the delay time or the level is exceeded, deactivation does not take place. There is no delay time for the dry run in the rainwater storage tank.
- Reactivation: When the contact is shut again or the level is exceeded, the system starts automatically.

NOTICE! The fault will be automatically reset, but it will be stored in the fault memory!

7.1.8 Operation with a defective pressure sensor

If the pressure sensor does not transfer a measured value (e.g. due to a wire break or defective sensor), all pumps are switched off. Furthermore, the red LED fault signal lights up and the collective fault signal is activated.

Emergency operation

To ensure water supply in the event of a fault, emergency operation can be activated. The set number of pumps is then started permanently:

- Menu 5.45
- Number of active pumps

7.1.9 Pump kick (cyclical test run)

To avoid longer periods of standstill for the activated pumps, a cyclical test run (pump kick function) is provided as a factory setting. **NOTICE! To deactivate this function: Menu 5.40!**

Observe the following points for this function:

- **Menu 5.41:** Pump kick permitted in “Extern OFF”
Start test run when the pumps are switched off using “Extern OFF”?
- **Menu 5.42:** Pump kick interval
Time interval after which a test run takes place. **NOTICE! The time interval will start when all pumps are switched off!**
- **Menu 5.43:** Pump kick running time
Pump running time during the test run

7.1.10 Calcination protection

To keep the valves functional even after prolonged operation with rainwater (Menu 5.54), the system switches the valves to fresh water for a defined time (Menu 5.75) while the pumps are not running to prevent calcination of the valves.

7.1.11 Flush function

To clean the system of suspended particles after prolonged operation with rainwater (Menu 5.55), the system switches to fresh water operation for a certain running time (Menu 5.56). After the specified running time has elapsed, the system switches back again.

Flushing takes place by switching the 3-way valves to fresh water when the pumps are in operation. Rainwater utilisation is deactivated for the corresponding period until the flushing time has been reached.

7.2 Menu control

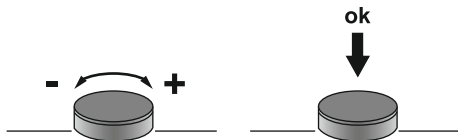

Fig. 22: Operating button function

The menu is controlled via the operating button:

- **Turn:** Menu selection or settings values.
- **Press:** Change menu level, confirm error number or value.

7.3 Menu type: Main menu or Easy Actions menu

There are two different menus.

- **Main menu:** Access to all settings for a complete configuration.
- **Easy Actions menu:** Quick access to certain functions.
Observe the following points when using the Easy Actions menu:
 - The Easy Actions menu only offers access to the selected functions. It is not possible to perform a complete configuration with this.
 - Perform an initial configuration to use the Easy Actions menu.
 - The Easy Actions menu is enabled at the factory. Note, the Easy Actions menu can be **disabled in menu 7.06.**

7.4 Call up the menu

Call up the main menu

1. Press operating button for 3 seconds.
 - ▶ Menu item 1.00 appears.

Call up the Easy Actions menu

1. Turn operating button 180°.
 - ⇒ The “Resetting error messages” or “Manual operation pump 1” function appears
2. Turn operating button an additional 180°.
 - ▶ The other functions are shown. The main screen appears at the end.

7.5 Quick access to “Easy Actions”

The following functions can be called up using the Easy Actions menu:

	Reset the current error message NOTICE! Menu item is only shown when an error is present!
	Manual operation pump 1 When the control knob is pressed, pump 1 runs. When the control knob is released, the pump switches off. The last set operating mode is active again.
	Manual operation pump 2 When the control knob is pressed, pump 2 runs. When the control knob is released, the pump switches off. The last set operating mode is active again.
	Pump 1 deactivated. Corresponds to the “off” value in Menu 3.02.

	Pump 2 deactivated. Corresponds to the “off” value in Menu 3.03.
	Automatic mode, pump 1 Corresponds to the “Auto” value in Menu 3.02.
	Automatic mode, pump 2 Corresponds to the “Auto” value in Menu 3.03.
	Manual operation valve 1 Corresponds to the “rain” value in Menu 3.06.
	Manual operation valve 2 Corresponds to the “rain” value in Menu 3.07.
	Manual operation valve 1 Corresponds to the “fresh” value in Menu 3.06.
	Manual operation valve 2 Corresponds to the “fresh” value in Menu 3.07.
	Automatic mode valve 1 Corresponds to the “Auto” value in Menu 3.06.
	Automatic mode valve 2 Corresponds to the “Auto” value in Menu 3.07.

7.6 Factory settings

To reset the switchgear to the factory settings, contact customer service.

8 Commissioning

8.1 Operator responsibilities



NOTICE

Observe additional documentation

- Carry out the commissioning measures in accordance with the installation and operating instructions for the overall system.
- Observe the installation and operating instructions for the connected products (sensors and pumps) as well as the system documentation.

- Provide installation and operating instructions at the switchgear or at a place specially reserved for it.
- Make the installation and operating instructions available in a language the personnel can understand.
- Make sure that the installation and operating instructions have been read and understood by all personnel.
- The installation site of the switchgear is overflow-proof.
- The switchgear is properly fused and earthed.
- Safety devices and precautions (incl. emergency off) for the entire system are switched on and have been checked for problem-free operation.
- The switchgear is suitable for use under the specified operating conditions.

8.2 Activating the switchgear

8.2.1 Possible error message during activation

Depending on the mains connection and the basic settings, the following error message may occur during activation. The error codes listed and their description apply to commissioning. A complete overview can be found in Chapter “Error codes”.

Code*	Faults	Cause	Remedies
E006	Rotating field error	<ul style="list-style-type: none"> • Incorrect rotating field • Operation with single-phase AC current connection. 	<ul style="list-style-type: none"> • Establish a clockwise rotating field at the mains connection. • Deactivate rotating field monitoring (menu 5.68)!

Code*	Faults	Cause	Remedies
E080.x	Pump fault	<ul style="list-style-type: none"> No pump connected. Motor current monitoring not set. 	<ul style="list-style-type: none"> Connect pump or deactivate minimum current monitoring (menu 5.69)! Set the motor current monitoring to the pump's rated current.

Key:

* "x" = represents the pump to which the fault shown applies.

8.2.2 Activating the device

**NOTICE****Observe the error code on the display**

If the red fault LED lights up or flashes, observe the error code on the display! If the error has been confirmed, the previous error will be stored in menu 6.02.

- ✓ Switchgear is closed.
 - ✓ Installation has been performed correctly.
 - ✓ All signal transmitters and consumers are connected and installed in the operating space.
 - ✓ If a low-water cut-out switchgear (dry-running protection) is available, the switching point has been correctly set.
 - ✓ Motor protection is preset according to the pump data.
1. Turn the main switch to the "ON" position.
 2. Switchgear starts.
 - All LEDs light up for 2 s.
 - The display illuminates and the start screen appears.
 - The standby symbol appears in the display.
- ▶ The switchgear is ready for operation. Start the initial configuration or automatic mode.

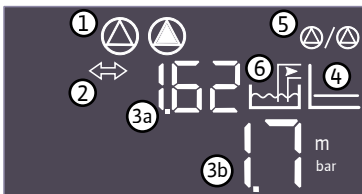

Fig. 23: Start screen

1	Current pump status: <ul style="list-style-type: none"> Number of registered pumps Pump activated/deactivated Pumps on/off
2	Fieldbus active
3a	<ul style="list-style-type: none"> Fill level actual value
3b	<ul style="list-style-type: none"> Actual pressure value
4	p-c control mode
5	Standby pump function activated
6	Current valve status: <ul style="list-style-type: none"> Rainwater utilisation Fresh water utilisation

8.3 Start initial configuration

Set the following parameters during initial configuration:

- Enable parameter input.
- Menu 5: Basic settings
- Menu 1: Activation/deactivation values
- Menu 2: Fieldbus connection (if available)
- Menu 3: Enable pumps.
- Set motor current monitoring.
- Check the direction of rotation of the connected pumps.

Observe the following points during the configuration:

- If there is no input or operation for 6 minutes:
 - the display illumination is switched off.
 - the display returns to the main screen.
 - parameter input is locked.
- Some settings can only be adjusted when there is no pump in operation.
- The menu is automatically adapted based on the settings. Example: The Menus 5.41 ... 5.43 are only visible when the "pump kick" function (Menu 5.40) is activated.

- The menu structure is valid for all EC switchgears (e.g. HVAC, Booster, Lift, Fire, etc.). This may lead to gaps in the menu structure.

8.3.1 Enable parameter input

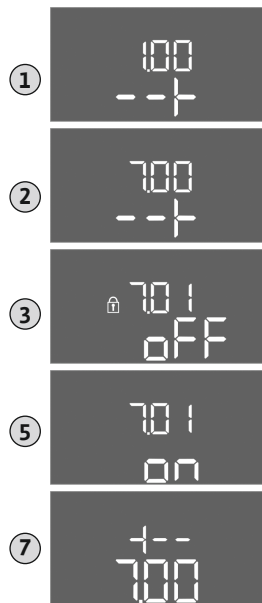

As standard, the values are only displayed. To change the values, the parameter input in Menu 7.01 must be enabled:

1. Press the operating button for 3 s.
⇒ Menu item 1.00 appears
2. Turn the operating button until menu 7 appears.
3. Press the operating button.
⇒ Menu 7.01 appears.
4. Press the operating button.
5. Change the value to “on”: Turn the operating button.
6. Save value: Press the operating button.
⇒ The menu is enabled and can be changed.
7. Turn the operating button until the end of menu 7 appears.
8. Press the operating button.
⇒ Back to the main menu level.
▶ Start initial configuration.

Fig. 24: Enable parameter input

8.3.2 Overview of available parameters

Parameter (menu item)	EC-rF (AF150)
1.00 Values for switching on and off	
1.01 Pressure setpoint	•
1.04 Activation threshold of the pump in % of pressure setpoint	•
1.07 Deactivation threshold of the base-load pump in % of pressure setpoint	•
1.08 Peak-load pump deactivation threshold in % of pressure setpoint	•
1.09 Deactivation delay base-load pump	•
1.10 Activation delay peak-load pump	•
1.11 Deactivation delay peak-load pump	•
1.12 Pump 1 Start level	–
1.13 Pump 1 Stop level	–
1.14 Pump 2 Start level	–
1.15 Pump 2 Stop level	–
2.00 Fieldbus connection for ModBus RTU	
2.01 ModBus RTU interface On/Off	•
2.02 Baud rate	•
2.03 User address	•
2.04 Parity	•
2.05 Stop bits	•
3.00 Enable pumps	
3.01 Enable pumps	•
3.02 Operating mode pump 1	•
3.03 Operating mode pump 2	•
3.06 Operating mode valve 1	•
3.07 Operating mode valve 2	•
3.10 Running time of pumps in manual operation	•

Parameter (menu item)	EC-rF (AF150)
3.12 Running time of the valves in manual operation	•
4.00 Information	
4.02 Current pressure value in bar	•
4.04 Current valve status	•
4.05 Status of the float switches (only with level sensor 5.07 = Float)	•
4.07 Time remaining until the next flush process	–
4.08 Current water level of fresh water tank	–
4.09 Current water volume of fresh water tank	–
4.10 Current water level of the rainwater storage tank	•
4.11 Current water volume of the rainwater storage tank	•
4.12 Running time of switchgear	•
4.13 Running time: Pump 1	•
4.14 Running time: Pump 2	•
4.17 Switching cycles switchgear	•
4.18 Switching cycle: Pump 1	•
4.19 Switching cycle: Pump 2	•
4.22 Serial number of switchgear	•
4.23 Switchgear type	•
4.24 Software version	•
4.25 Set value for the motor current monitoring: Pump 1	•
4.26 Set value for the motor current monitoring: Pump 2	•
4.29 Actual current in A for pump 1	•
4.30 Actual current in A for pump 2	•
4.34 Running time: Valve 1	•
4.35 Running time: Valve 2	•
4.38 Switching cycle: Valve 1	•
4.39 Switching cycle: Valve 2	•
4.46 Fresh water utilisation time	•
4.47 Dry run meter for rainwater storage tank	•
4.48 Overflow meter for rainwater storage tank	•
5.00 Basic settings	
5.01 Control mode	•
5.02 Number of connected pumps	•
5.03 Standby pump	•
5.07 Signal detection for fresh water tank fill level	–
5.10 Rainwater storage tank signal detection	•
5.11 Pressure sensor measurement range	•
5.17 Overpressure detection limit value	•
5.18 Underpressure detection limit value	•
5.20 Measurement range for fresh water tank filling level sensor	–
5.21 Installation height for fresh water tank filling level sensor	–
5.22 Fresh water tank dry-running threshold	–
5.23 Threshold for high fill level of fresh water tank	–
5.24 Fresh water tank overflow threshold	–
5.26 Shape of fresh water tank	–
5.27 Height of fresh water tank	–
5.30 Measurement range for filling level sensor of rainwater storage tank	•

Parameter (menu item)	EC-rF (AF150)
5.31 Installation height for filling level sensor of rainwater storage tank	•
5.32 Dry-running threshold for rainwater storage tank	•
5.34 Overflow threshold for rainwater storage tank	•
5.35 High-water threshold for rainwater storage tank	•
5.36 Shape of the rainwater storage tank	•
5.37 Height of the rainwater storage tank	•
5.39 External alarm off	•
5.40 Switch “pump kick” function On/Off	•
5.41 “Pump kick” for External OFF allowed	•
5.42 “Pump kick interval”	•
5.43 “Pump kick duration”	•
5.44 Delay system	•
5.45 Behaviour during sensor fault – number of pumps to be switched on	•
5.52 Fresh water activation threshold	•
5.53 Fresh water deactivation threshold	•
5.54 Interval of calcination protection	•
5.55 Interval of “flush system”	•
5.56 Duration of the flushing process	•
5.58 Collective run signal (SBM) function	•
5.59 Collective fault signal (SSM) function	•
5.60 Pump cycling	•
5.62 Low water level (dry-running protection): Deactivation delay	•
5.67 Output of rotating warning light	•
5.68 Mains connection rotating field monitoring On/Off	•
5.69 Minimum motor current monitoring On/Off	•
5.73 Reaction to underpressure	•
5.74 Delay in pressure monitoring	•
5.75 Duration of calcination protection	•
5.76 Auxiliary output of delay time	•

Table 2: Available parameters

8.3.3 Menu 5: Basic settings



Fig. 25: Menu 5.00

Menu no.	5.00
Name	Installation
Description	Settings made during the installation of the switchgear.



Fig. 26: Menu 5.01

Menu no.	5.01
Name	Control mode
Value range	Auto, Fresh, Rain
Factory setting	Auto
Description	The active control mode of the switchgear. The water source to be used (fresh water or rainwater) is adjusted here. An alarm is triggered if the control mode is not set to Auto. <ul style="list-style-type: none"> • “Fresh” control mode: The system is only operated with fresh water. • “Rain” control mode: The system is only operated with rainwater. • “Auto” control mode: The system automatically switches between rainwater and fresh water.



Fig. 27: Menu 5.02

Menu no.	5.02
Name	Number of pumps
Value range	1 ... 2
Factory setting	1
Description	Number of pressure-boosting pumps in the system

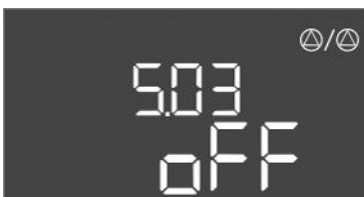

Fig. 28: Menu 5.03

Menu no.	5.03
Name	Standby pump
Value range	on, off
Factory setting	off
Description	Determines whether or not a pump should be kept in stock as a replacement for a failed pump.



Fig. 29: Menu 5.10

Menu no.	5.10
Name	Signal detection of rainwater storage tank fill level
Value range	Level, both
Factory setting	Level
Description	Determines whether the rainwater storage tank is equipped with a filling level sensor or additionally with a float switch.



Fig. 30: Menu 5.11

Menu no.	5.11
Name	Pressure sensor measurement range
Value range	1 to 25 bar
Factory setting	16 bar
Description	Defines the end value for the pressure range of the sensor.



Fig. 31: Menu 5.17

Menu no.	5.17
Name	Overpressure detection threshold
Value range	0.0 to 16.0 bar
Factory setting	8.0 bar
Description	The limit value above which an overpressure alarm is triggered must be higher than the threshold for deactivation of the pump.



Fig. 32: Menu 5.18

Menu no.	5.18
Name	Underpressure detection threshold
Value range	0.0 to 16.0 bar
Factory setting	1.0 bar
Description	Can be used for dry-running protection or leakage detection and must be lower than the activation threshold of the pumps. Intended for EC-Rain as dry-running protection.



Fig. 33: Menu 5.30

Menu no.	5.30
Name	Measurement range for rainwater storage tank filling level sensor
Value range	1.00 – 10.00 m
Factory setting	5.00 m
Description	Defines the end value of the filling level sensor for the rainwater storage tank in metres.



Fig. 34: Menu 5.31

Menu no.	5.31
Name	Installation height for rainwater storage tank filling level sensor
Value range	0.00 – 10.00 m
Factory setting	0.25 m
Description	Distance between the bottom of the rainwater storage tank and the installation height of the filling level sensor in metres.



Fig. 35: Menu 5.32

Menu no.	5.32
Name	Rainwater storage tank dry-running threshold
Value range	0.00 – 10.00 m
Factory setting	0.05 m
Description	The threshold in the rainwater storage tank below which a dry run is recorded. Is specified in relation to the installation height of the sensor. Must be less than 5.52.



Fig. 36: Menu 5.34

Menu no.	5.34
Name	Threshold overflow / rainwater storage tank
Value range	0.01 – 10.00 m
Factory setting	2.50 m
Description	The threshold in the rainwater storage tank above which an overflow is recorded. Is specified in relation to the bottom of the rainwater storage tank. Must be greater than 5.52+5.53.



Fig. 37: Menu 5.35

Menu no.	5.35
Name	Threshold high water / rainwater storage tank
Value range	0.00 – 10.00 m
Factory setting	0.25 m
Description	The threshold in the rainwater storage tank above which high water is recorded. The level is specified as an overflow threshold function (5.34). If the level is 0, the high water alarm is deactivated.

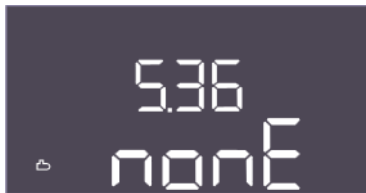

Fig. 38: Menu 5.36

Menu no.	5.36
Name	Shape of the rainwater storage tank
Value range	none, rect, cylin, hcyli, spher
Factory setting	none
Description	<p>If the rainwater storage tank has a defined shape, this can be selected here and used to calculate the water volume. In case of "none", the water level is displayed for the rainwater storage tank instead of the volume.</p> <ul style="list-style-type: none"> • Rect = rainwater storage tank with rectangular base • Cylin = upright cylindrical rainwater storage tank • Hcyli = horizontal cylindrical rainwater storage tank • Spher = spherical rainwater storage tank



Fig. 39: Menu 5.37

Menu no.	5.37
Name	Height of rainwater storage tank
Value range	0.01 – 10.00 m
Factory setting	2.00 m
Description	<p>The height of the rainwater storage tank, specified in metres, is required to calculate the current water volume, given as a percentage. The height is displayed from the bottom of the rainwater storage tank. Must be greater than 5.34+5.35.</p>



Fig. 40: Menu 5.39

Menu no.	5.39
Name	Alarm signal with active "Extern OFF" input
Value range	off, on
Factory setting	off
Description	<p>If "Extern OFF" is used as input for a float switch, a "Priority Off" alarm can be activated.</p>



Fig. 41: Menu 5.40

Menu no.	5.40
Name	Pump kick
Value range	off, on
Factory setting	on
Description	<p>Switch the "Pump kick" function on or off:</p> <ul style="list-style-type: none"> • off = pump kick deactivated • on = pump kick activated



Fig. 42: Menu 5.41

Menu no.	5.41
Name	"Pump kick" for Extern OFF
Value range	off, on
Factory setting	on
Description	<p>Select whether a pump kick may take place or not if the Extern OFF input is active:</p> <ul style="list-style-type: none"> • off = pump kick deactivated if Extern OFF is active. • on = pump kick activated if Extern OFF is active.



Fig. 43: Menu 5.42



Fig. 44: Menu 5.43



Fig. 45: Menu 5.44



Fig. 46: Menu 5.45



Fig. 47: Menu 5.52



Fig. 48: Menu 5.53

Menu no.	5.42
Name	“Pump kick interval”
Value range	1 ... 336 h
Factory setting	6 h
Description	The time interval between two test runs or after all pumps have stopped.

Menu no.	5.43
Name	“Pump kick” duration
Value range	0 ... 60 s
Factory setting	5 s
Description	The switch-on time of the pump during the test run

Menu no.	5.44
Name	Delay system
Value range	0 – 300 s
Factory setting	0 s
Description	Waiting time after activation of the switchgear until a pump can be started. This can be utilised when using several switchgears in order to reduce power peaks by starting them simultaneously.

Menu no.	5.45
Name	Number of pumps with sensor error
Value range	0 – 3
Factory setting	0
Description	Defines the number of pumps to be started if a pressure sensor error has occurred.

Menu no.	5.52
Name	Fresh water activation threshold
Value range	0.01 – 1.00 m
Factory setting	0.15 m
Description	The threshold below which switchover to fresh water utilisation should take place. The threshold is specified in relation to the installation height of the sensor.

Menu no.	5.53
Name	Threshold switch off fresh water / rainwater utilisation
Value range	0.02 – 1.00 m
Factory setting	0.25 m
Description	The threshold above which fresh water use is stopped and the switchover to rainwater takes place. The threshold is specified relative to Menu 5.52.



Fig. 49: Menu 5.54



Fig. 50: Menu 5.55



Fig. 51: Menu 5.56



Fig. 52: Menu 5.58



Fig. 53: Menu 5.59



Fig. 54: Menu 5.60

Menu no.	5.54
Name	Calcination protection
Value range	0 – 7 d
Factory setting	7 d
Description	The solenoid valve can be opened after the set time to stop it from becoming stuck due to calcination.

Menu no.	5.55
Name	Flushing the system
Value range	7 – 31 d
Factory setting	21 d
Description	The flushing interval can be set here to ensure the system is flushed and the water is exchanged with fresh water.

Menu no.	5.56
Name	Flushing time
Value range	1 – 9 min
Factory setting	3 min
Description	Duration of flushing the system with fresh water

Menu no.	5.58
Name	Collective run signal (SBM) behaviour
Value range	on, run
Factory setting	run
Description	The mode for the collective run signal: <ul style="list-style-type: none"> • “on”: Switchgear ready for operation • “run”: At least one pump is running.

Menu no.	5.59
Name	Collective fault signal (SSM) behaviour
Value range	fall, raise
Factory setting	raise
Description	The switching behaviour of the collective fault signal: <ul style="list-style-type: none"> • “fall”: falling edge • “raise”: rising edge

Menu no.	5.60
Name	Pump cycling
Value range	off, 1 – 6 h
Factory setting	6 h
Description	Pumps automatically cycled during operation after the set time. “off” deactivates the function.



Fig. 55: Menu 5.62



Fig. 56: Menu 5.68



Fig. 57: Menu 5.69



Fig. 58: Menu 5.73

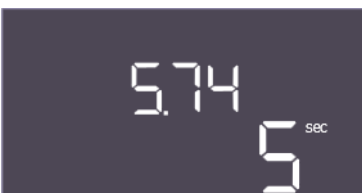

Fig. 59: Menu 5.74



Fig. 60: Menu 5.75

Menu no.	5.62
Name	Delay dry-running protection
Value range	0 – 180 s
Factory setting	15 s
Description	The delay for detecting dry run to avoid false alarms caused by short impulses.

Menu no.	5.68
Name	Rotating field detection
Value range	on, off
Factory setting	on
Description	Activation or deactivation of the phase rotating field detection when single-phase pumps are used. <ul style="list-style-type: none"> off = rotating field detection deactivated on = rotating field detection activated

Menu no.	5.69
Name	Minimum current detection pumps
Value range	on, off
Factory setting	on
Description	Activate or deactivate undercurrent detection for the pumps: <ul style="list-style-type: none"> off = minimum current detection deactivated on = minimum current detection activated

Menu no.	5.73
Name	Reaction to underpressure detection
Value range	off, Cont
Factory setting	Cont
Description	The reaction of the system when underpressure is detected: <ul style="list-style-type: none"> Cont: The system continues to operate normally. Collective fault signal is activated. off: The system is stopped. A manual reset is necessary.

Menu no.	5.74
Name	Delay pressure monitoring
Value range	1 – 60 s
Factory setting	5 s
Description	The delay for detecting overpressure or underpressure. It prevents false detection using a short impulse.

Menu no.	5.75
Name	Duration of calcination protection
Value range	1 – 60 s
Factory setting	3 s
Description	Duration, how long the solenoid valve should remain open.



Fig. 61: Menu 5.76



Fig. 62: Back to Menu 5.00

8.3.4 Menu 1: Values for switching on and off



Fig. 63: Menu 1.00

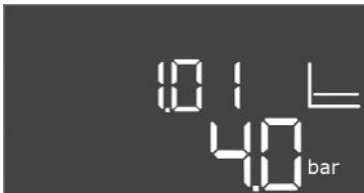

Fig. 64: Menu 1.01

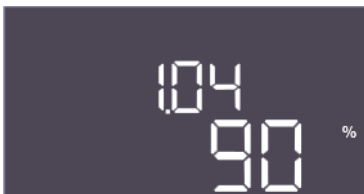

Fig. 65: Menu 1.04



Fig. 66: Menu 1.07

Menu no.	5.76
Name	Delay time for auxiliary output pumps
Value range	-60 to 60 s
Factory setting	2 s
Description	Time-delayed auxiliary output relative to the start of the pressure-boosting pumps. (+ means after, - means before).

Description	Back to main menu
-------------	-------------------

Menu no.	1.00
Name	Setpoints
Description	Setting the control setpoints

Menu no.	1.01
Name	Pressure setpoint
Value range	0.1 – 16.0 bar
Factory setting	4 bar
Description	The pressure setpoint defines the desired pressure at the output.

Menu no.	1.04
Name	Pump start activation threshold
Value range	75 – 99%
Factory setting	90%
Description	Activation threshold of the pump in % of the pressure setpoint for starting the base-load pump or for pumps in general

Menu no.	1.07
Name	Deactivation threshold for base-load pump
Value range	101 – 150%
Factory setting	115 %
Description	Deactivation threshold of the base-load pump in % of the pressure setpoint for stopping the base-load pump when only this is running.



Fig. 67: Menu 1.08



Fig. 68: Menu 1.09



Fig. 69: Menu 1.10



Fig. 70: Menu 1.11



Fig. 71: Back to Menu 1.00

8.3.5 Menu 2: ModBus RTU connection



Fig. 72: Menu 2.00

Menu no.	1.08
Name	Deactivation threshold for peak-load pumps
Value range	101 – 125%
Factory setting	110 %
Description	Deactivation threshold of the peak-load pumps in % of the pressure setpoint for stopping a peak-load pump when 2 pumps are running.

Menu no.	1.09
Name	Base-load pump deactivation delay
Value range	0 to 120 s
Factory setting	10 s
Description	Delays the stop of the base-load pump when the stop threshold has been reached and the actual value remains permanently above the deactivation threshold.

Menu no.	1.10
Name	Peak-load pump activation delay
Value range	1 – 30 s
Factory setting	4 s
Description	Delay for starting a peak-load pump when the start threshold has been reached and the current value remains permanently above the activation threshold.

Menu no.	1.11
Name	Peak-load pump switch-off delay
Value range	0 ... 30 s
Factory setting	8 s
Description	Delays the stop of a peak-load pump when the stop threshold has been reached and the actual value remains permanently above the deactivation threshold.

Description	Back to main menu
-------------	-------------------

The switchgear is equipped with an RS485 interface for connection via ModBus RTU. Different parameters can be read and changed to some extent via the interface. In this case, the switchgear works as a Modbus Slave. An overview of individual parameters and a description of the data types used are shown in the appendix.

To use the ModBus interface, the settings must be changed in the following menus:

Menu no.	2.00
Name	Communication settings
Description	ModBus setting



Fig. 73: Menu 2.01



Fig. 74: Menu 2.02



Fig. 75: Menu 2.03



Fig. 76: Menu 2.04



Fig. 77: Menu 2.05



Fig. 78: Back to Menu 2.00

8.3.6 Menu 3: Enable pumps

Menu no.	2.01
Name	ModBus RTU interface On/Off
Value range	on, off
Factory setting	on
Description	Switch the ModBus interface on or off.

Menu no.	2.02
Name	Baud rate
Value range	9600; 19200; 38400; 76800
Factory setting	19200
Description	Set the ModBus transmission rate according to the connected bus.

Menu no.	2.03
Name	User address
Value range	1 – 254
Factory setting	10
Description	User address of the Control EC-RAIN in the ModBus network

Menu no.	2.04
Name	Parity
Value range	none, even, odd
Factory setting	even
Description	Parity setting for the ModBus RTU serial connection

Menu no.	2.05
Name	Stop bits
Value range	1; 2
Factory setting	1
Description	Number of stop bits for the ModBus RTU serial connection

Description	Back to main menu
-------------	-------------------

To operate the system, the operating mode must be set for each pump and the pumps enabled:

- Every pump is set to the “auto” operating mode as the factory setting.
- Automatic mode starts after the pumps have been enabled in Menu 3.01.

Required settings for the initial configuration

Carry out the following work during the initial configuration:



Fig. 79: Menu 3.00



Fig. 80: Menu 3.01



Fig. 81: Menu 3.02



Fig. 82: Menu 3.03



Fig. 83: Menu 3.06

- Check direction of rotation of the pumps
- Set precise motor current monitoring (“Control EC–Booster” only)

Use the following settings to carry out this work:

- Switch off the pumps: Set menus 3.02 to 3.04 to “off”.
- Enable pumps: Menu 3.01 set to “on”.

Menu no.	3.00
Name	Operating settings
Description	Settings for the drives and mode of the pumps and solenoid valves

Menu no.	3.01
Name	Enable pumps
Value range	on, off
Factory setting	off
Description	Deactivation or release of all pumps <ul style="list-style-type: none"> • Deactivates the pressure–boosting pumps.

Menu no.	3.02
Name	Operating mode for pressure–boosting pump 1
Value range	off, Hand, Auto
Factory setting	Auto
Description	For the operating mode of pressure–boosting pump 1, manual on (hand–operated), manual off (off) and automatic mode can be selected. In manual operation, alarms such as dry run and thermal winding contact are still taken into account.

Menu no.	3.03
Name	Operating mode for pressure–boosting pump 2
Value range	off, Hand, Auto
Factory setting	Auto
Description	For the operating mode of pressure–boosting pump 2, manual on (hand–operated), manual off (off) and automatic mode can be selected. In manual operation, alarms such as dry run and thermal winding contact are still taken into account.

Menu no.	3.06
Description	Operating mode, valve 1
Value range	Rain, Fresh, Auto
Factory setting	Auto
Explanation	The 3–way valve 1 can be operated manually for fresh water or rainwater or automatically. During manual operation, safety alarms such as dry run or thermal winding contact are still observed.



Fig. 84: Menu 3.07



Fig. 85: Menu 3.10



Fig. 86: Menu 3.12



Fig. 87: Back to Menu 3.00

8.3.7 Adjust motor current monitoring

Menu no.	3.07
Description	Operating mode, valve 2
Value range	Rain, Fresh, Auto
Factory setting	Auto
Explanation	The 3-way valve 2 can be operated manually for fresh water or rainwater or automatically. During manual operation, safety alarms such as dry run or thermal winding contact are still observed.

Menu no.	3.10
Name	Running time of pumps in manual operation
Value range	0 to 999 s
Factory setting	90 s
Description	Duration, how long the pump is set to manual mode: <ul style="list-style-type: none"> • 0: Running time as long as the button is pressed • 1-998: Running time in seconds, then switch to the previous mode • 999: Unlimited running time

Menu no.	3.12
Name	Running time of solenoid valves in manual operation
Value range	0 to 999 s
Factory setting	10 s
Description	Duration, how long the solenoid valve is set to manual mode: <ul style="list-style-type: none"> • 0: Running time as long as the button is pressed • 1-998: Running time in seconds, then switch to the previous mode • 999: Unlimited running time

Description	Back to main menu
-------------	-------------------

Display the current value of the motor current monitoring

1. Press the control knob for 3 s.
⇒ Menu 1.00 appears.
2. Turn the control knob until Menu 4.00 appears.
3. Press the control knob.
⇒ Menu 4.01 appears.
4. Turn the control knob until menu 4.25 to 4.26 appears.
⇒ Menu 4.25: Shows the set motor current for pump 1.
⇒ Menu 4.26: Shows the set motor current for pump 2.
▶ Current value of the motor current monitoring checked.
Compare the set value with the specification on the rating plate. If the set value differs from the specification on the rating plate, adjust the value.

Adjust the motor current monitoring value



DANGER

Risk of fatal injury due to electrical current!

There is danger of death when performing work on the open switchgear. The components carry current.

- Have work carried out by a qualified electrician.
- Avoid contact with earthed metal parts (pipes, frames etc.).

- ✓ Motor current monitoring settings checked.
1. Turn the control knob until menu 4.25 to 4.26 appears.
 - ⇒ Menu 4.25: Shows the set motor current for pump 1.
 - ⇒ Menu 4.26: Shows the set motor current for pump 2.
 2. Open the switchgear.
 3. Correct the motor current on the potentiometer with a screwdriver (see “Overview of components”). Read changes directly off the display.
 4. Once all of the motor currents have been corrected, close the switchgear.
 - ▶ Motor current monitoring set. Perform direction of rotation check.

8.3.8 Check the direction of rotation of the connected pumps



NOTICE

Power supply and pump connection rotating field

The rotating field is routed from the mains connection directly to the pump connection.

- Check the required rotating field of the pumps to be connected (clockwise or counter-clockwise).
- Observe the installation and operating instructions of the pumps.

Perform a test run to check the direction of rotation of the pumps. **CAUTION! Property damage! Perform the test run under the prescribed operating conditions.**

- ✓ The switchgear is closed.
 - ✓ Configuration of menu 5 and menu 1 complete.
 - ✓ All pumps are switched off in menu 3.02 to 3.03: Value is “off”.
 - ✓ The pumps are enabled in menu 3.01: Value is “on”.
1. Start Easy Actions menu: Turn control knob 180°.
 2. Select the pump’s manual operation mode: Turn the control knob until the menu item is displayed:
 - Pump 1: P1 Hand
 - Pump 2: P2 Hand
 3. Start test run: Press the control knob. Pump runs for the set time (Menu 3.10) and then switches off again.
 4. Check direction of rotation.
 - ⇒ **Incorrect direction of rotation:** Exchange two phases on the pump connection.
 - ▶ Direction of rotation checked and corrected as necessary. The initial configuration is complete.

8.4 Start automatic mode

Automatic mode after initial configuration

- ✓ The switchgear is closed.
 - ✓ Configuration complete.
 - ✓ Direction of rotation correct.
 - ✓ Motor current monitoring set correctly.
1. Start Easy Actions menu: Turn control knob 180°.
 2. Select the pump for automatic mode: Turn the control knob until the menu item is displayed:
 - Pump 1: P1 Auto
 - Pump 2: P2 Auto
 3. Press the control knob.
 - ⇒ Automatic mode is set for the selected pump. Alternatively, setting can be performed in menu 3.02 to 3.03.

- ▶ Automatic mode switched on.

Automatic mode after shutdown

- ✓ The switchgear is closed.
 - ✓ Checked configuration.
 - ✓ Parameter input enabled: Menu 7.01 shows on.
1. Press the control knob for 3 s.
⇒ Menu 1.00 appears.
 2. Turn the control knob until menu 3.00 appears
 3. Press the control knob.
⇒ Menu 3.01 appears.
 4. Press the control knob.
 5. Change value to "on".
 6. Press the control knob.
⇒ Value saved, pump enabled.
- ▶ Automatic mode switched on.

8.5 During operation

Make sure the following points are observed during operation:

- Keep the switchgear closed and secure it against unauthorised opening.
- Switchgear attached in an overflow-proof manner (protection class IP54).
- Not exposed to direct sunlight.
- Ambient temperature: 0 – 40 °C.

The following items of information are shown on the main screen:

- Pump status:
 - Number of registered pumps
 - Pump activated/deactivated
 - Pump On/Off
- Operation with standby pump
- Control mode
- Actual pressure value, actual fill level value or float switch status
- Active fieldbus operation

Furthermore, the following information is available via Menu 4:

1. Press the control knob for 3 s.
⇒ Menu 1.00 appears.
2. Turn the control knob until Menu 4 appears.
3. Press the control knob.
▶ Menu 4.xx appears.



Fig. 88: Menu 4.00



Fig. 89: Menu 4.02

Menu no.	4.00
Name	Information
Description	Current operating data for pumps and switchgear

Menu no.	4.02
Name	Actual pressure value in bar
Value range	0.0 – 16.0 bar
Factory setting	0.0 bar
Description	Value measured by the pressure sensor on the output side.



Fig. 90: Menu 4.04

Menu no.	4.04
Name	Current valve status
Description	Status of installed valves: <ul style="list-style-type: none"> • 1 = actuated (fresh water) • 0 = not actuated (rainwater) Status of 3-way valves (valve 1: *X, valve 2: X*, where X is 0 or 1 and * is not relevant).

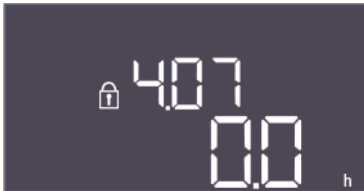

Fig. 91: Menu 4.07

Menu no.	4.07
Name	Hours remaining until the next flush
Value range	0.0 – 999.9 h
Description	The remaining time of uninterrupted use of rainwater until the system switches to using fresh water for cleaning the tank and pipes.



Fig. 92: Menu 4.10

Menu no.	4.10
Name	Current water level in the rainwater storage tank
Value range	0.00 – 10.00 m
Description	Current water level in the rainwater storage tank filled with rainwater



Fig. 93: Menu 4.11

Menu no.	4.11
Name	Current water volume in the rainwater storage tank
Description	The calculated value of the current water volume in the rainwater storage tank, if the height is specified.



Fig. 94: Menu 4.12

Menu no.	4.12
Name	Switchgear running time
Description	Total runtime during which the switchgear was supplied with voltage. <ul style="list-style-type: none"> • For the whole system



Fig. 95: Menu 4.13

Menu no.	4.13
Name	Running time pump 1
Description	Operating hours of pump 1 with rotating motor.



Fig. 96: Menu 4.14



Fig. 97: Menu 4.17



Fig. 98: Menu 4.18



Fig. 99: Menu 4.19



Fig. 100: Menu 4.22



Fig. 101: Menu 4.23

Menu no.	4.14
Name	Running time pump 2
Description	Operating hours of pump 2 with rotating motor.

Menu no.	4.17
Name	Switchgear switching cycles
Value range	0 – 65535
Description	Number of switch-on and switch-off switchgear cycles

Menu no.	4.18
Name	Switching cycles of pump 1
Value range	0 – 65535
Description	Number of starts and stops for pump 1

Menu no.	4.19
Name	Switching cycles of pump 2
Value range	0 – 65535
Description	Number of starts and stops for pump 2

Menu no.	4.22
Name	Serial number switchgear
Description	The serial number can be changed as long as the switchgear's number of switching cycles is less than or equal to 5. After that, it can no longer be changed.

Menu no.	4.23
Name	Switchgear type
Value range	EC-rF, EC-rh
Factory setting	EC-rF
Description	Type of switchgear for Control EC-Rain (rainwater utilisation): <ul style="list-style-type: none"> • EC-rF for the AF150 • EC-rh for the AF400



Fig. 102: Menu 4.24



Fig. 103: Menu 4.25



Fig. 104: Menu 4.26



Fig. 105: Menu 4.29



Fig. 106: Menu 4.30



Fig. 107: Menu 4.34

Menu no.	4.24
Name	Software version
Description	Version for the software used in the switchgear

Menu no.	4.25
Name	Set value for the motor current monitoring: Pump 1
Value range	0.0 – 12.0
Factory setting	0.0
Description	Value for the maximum rated current in A for pump 1, which was set on the potentiometer on the printed circuit board.

Menu no.	4.26
Name	Set value for the motor current monitoring: Pump 2
Value range	0.0 – 12.0
Factory setting	0.0
Description	Value for the maximum rated current in A for pump 2, which was set on the potentiometer on the printed circuit board.

Menu no.	4.29
Name	Actual current in A for pump 1
Description	Displays the current measured in A for pump 1: <ul style="list-style-type: none"> • Single-phase pump: L1 • Three-phase pump: the display alternates regularly between L1, L2 and L3.

Menu no.	4.30
Name	Actual current in A for pump 2
Description	Displays the current measured in A for pump 2: <ul style="list-style-type: none"> • Single-phase pump: L1 • Three-phase pump: the display alternates regularly between L1, L2 and L3.

Menu no.	4.34
Name	Running time of valve 1
Description	Amount of time valve 1 has been actuated. <ul style="list-style-type: none"> • 3-way valve 1



Fig. 108: Menu 4.35



Fig. 109: Menu 4.38



Fig. 110: Menu 4.39



Fig. 111: Menu 4.46



Fig. 112: Menu 4.47



Fig. 113: Menu 4.48

Menu no.	4.35
Name	Running time of valve 2
Description	Amount of time valve 2 has been actuated. <ul style="list-style-type: none"> • 3-way valve 2

Menu no.	4.38
Name	Switching cycles of valve 1
Value range	0 – 65535
Description	The number of switching cycles where valve 1 was actuated. <ul style="list-style-type: none"> • 3-way valve 1

Menu no.	4.39
Name	Switching cycles of valve 2
Value range	0 – 65535
Description	The number of switching cycles where valve 2 was actuated. <ul style="list-style-type: none"> • 3-way valve 2

Menu no.	4.46
Name	Fresh water utilisation time
Value range	0 – 65535 min
Description	Total time in which the system has consumed fresh water. <ul style="list-style-type: none"> • Total in which the 3-way valves were in fresh water mode.

Menu no.	4.47
Name	Dry-running meter for rainwater storage tank
Value range	0 – 65535
Description	Counts the number of times the rainwater storage tank fill level was below the dry-running level.

Menu no.	4.48
Name	Overflow meter for rainwater storage tank
Value range	0 – 65535
Description	Counts the number of times the rainwater storage tank fill level was above the overflow level.



Fig. 114: Back to Menu 4.00

Description	Back to main menu
-------------	-------------------

9 Shut-down

9.1 Personnel qualifications

- Electrical work: qualified electrician
Person with appropriate technical training, knowledge and experience who can identify and prevent electrical hazards.
- Installation/dismantling work: qualified electrician
Knowledge regarding tools and fixation material for various structures

9.2 Operator responsibilities

- Observe locally applicable accident prevention and safety regulations of trade associations.
- Make sure that the personnel has had the corresponding training for the specified work.
- Train the personnel on how the system operates.
- When working in enclosed spaces, a second person must be present for safety reasons.
- Ensure enclosed spaces have sufficient ventilation.
- Take immediate countermeasures if there is a build-up of toxic or suffocating gases!

9.3 Shut-down

To decommission the pumps, switch off the pumps and switchgear at the main switch. The settings are stored in non-volatile memory in the switchgear and are not deleted. This ensures that the switchgear is always ready for operation. Adhere to the following points during the standstill period:

- Ambient temperature: 0 – 40 °C
 - Max. humidity: 90%, non-condensing
 - ✓ Parameter input enabled: Menu 7.01 shows on.
1. Press the operating button for 3 s.
⇒ Menu 1.00 appears.
 2. Turn the operating button until menu 3.00 appears
 3. Press the operating button.
⇒ Menu 3.01 appears.
 4. Press the operating button.
 5. Change value to “off”.
 6. Press the operating button.
⇒ Value saved, pump switched off.
 7. Turn main switch to the “OFF” position.
 8. Secure the main switch against being activated by unauthorised persons (e.g. lock main switch)
 - ▶ Switchgear switched off.

9.4 Removal



DANGER

Danger of death due to electrical current!

Improper conduct when carrying out electrical work can lead to death due to electric shock!

- Before all electrical work, disconnect the product from the mains and secure it against being switched on again without authorisation.
- Electrical work must be carried out by a qualified electrician!
- Observe local regulations!

- ✓ Decommissioning performed.
- ✓ Mains connection is switched so that it is voltage-free and safeguarded against being activated by unauthorised persons.
- ✓ The power connection for fault and run signals is switched so that it is voltage-free and safeguarded against being activated by unauthorised persons.

1. Open the switchgear.
2. Disconnect all connection cables and pull them out through the threaded cable connection.
3. Close off the ends of the connection cables watertight.
4. Seal threaded cable connections watertight.
5. Support the switchgear (e.g. get a second person to help).
6. Loosen the switchgear fastening screws and remove the switchgear from the structure.
 - ▶ Switchgear removed. Observe the following for storage!

10 Maintenance



DANGER

Danger of death due to electrical current!

Improper conduct when carrying out electrical work can lead to death due to electric shock!

- Before all electrical work, disconnect the product from the mains and secure it against being switched on again without authorisation.
- Electrical work must be carried out by a qualified electrician!
- Observe local regulations!



NOTICE

Unauthorised work or structural changes are prohibited!

Only maintenance and repair work described in this manual may be carried out. All other works and any alterations to the construction may only be carried out by the manufacturer.

10.1 Maintenance intervals

Regular

- Clean switchgear.

Annually

- Check electro-mechanical components for wear.

After 10 years

- General overhaul

10.2 Maintenance tasks

Cleaning switchgear

- ✓ Switch off switchgear.

1. Clean switchgear with a damp cotton cloth.

Do not use any aggressive or scouring cleaners or fluids!

Check electro-mechanical components for wear

- Have electro-mechanical components checked for wear by an electrician.
- If wear is ascertained, have the affected components replaced by an electrician or by the Wilo Customer Service.

General overhaul

During a general overhaul, all of the components, wiring and the housing are checked for wear. Defective or worn components are replaced.

11 Faults, causes and remedies



DANGER

Danger of death due to electrical current!

Improper conduct when carrying out electrical work can lead to death due to electric shock!

- Before all electrical work, disconnect the product from the mains and secure it against being switched on again without authorisation.
- Electrical work must be carried out by a qualified electrician!
- Observe local regulations!

11.1 Operator responsibilities

- Observe locally applicable accident prevention and safety regulations of trade associations.
- Make sure that the personnel has had the corresponding training for the specified work.
- Train the personnel on how the system operates.
- When working in enclosed spaces, a second person must be present for safety reasons.
- Ensure enclosed spaces have sufficient ventilation.
- Take immediate countermeasures if there is a build-up of toxic or suffocating gases!

11.2 Fault indication

Possible faults are shown by the fault LEDs and alphanumeric codes on the display.

- Have the system checked according to the displayed fault.
- Have the defective components replaced.

Faults are displayed in various ways:

- Fault in the control/on the switchgear:
 - The red fault signal LED **lights up**.
 - Display of the error code alternates with the main screen. The error code is stored in the fault memory.
 - The collective fault signal is activated.
- Pump fault
 - **Status icon** of the respective pump **flashes** on the display.

11.3 Fault acknowledgement

Switch off the alarm display by pressing the operating button. Acknowledge the fault via the main menu or Easy Actions menu.

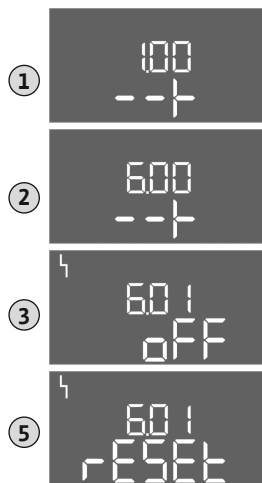

Fig. 115: Acknowledge fault

Main menu

- ✓ All faults rectified.
1. Press the operating button for 3 s.
⇒ Menu 1.00 appears.
 2. Turn the operating button until menu 6 appears.
 3. Press the operating button.
⇒ Menu 6.01 appears.
 4. Press the operating button.
 5. Change the value to "reset": Turn the operating button.
 6. Press the operating button.
 - ▶ The fault indication is reset.

Easy Actions menu

- ✓ All faults rectified.
1. Starting the Easy Actions menu: Turn the operating button 180°.
 2. Select menu item "Err reset".
 3. Press the operating button.
 - ▶ The fault indication is reset.

Fault acknowledgement failed

If there are further faults, the faults are displayed as follows:

- The fault LED lights up.
- The error code of the last fault is shown in the display.
All other faults can be called up from the fault memory.

If all faults have been rectified, acknowledge the faults again.

11.4 Fault memory

The switchgear stores the last ten faults in the fault memory. The fault memory works according to the first in/first out principle. The faults are displayed in descending order in the menu items 6.02 to 6.11:

- 6.02: the last/latest fault
- 6.11: the oldest fault

11.5 Error codes

The functions may operate differently depending on the software version. That is why a software version is included with every error code.

The details regarding the software version used can be read on the rating plate or displayed via menu 4.24.

Code*	Faults	Cause	Remedies
E006	Rotating field error	<ul style="list-style-type: none"> • Incorrect rotating field • Operation via single-phase current connection 	<ul style="list-style-type: none"> • Establish a clockwise rotating field at the mains connection. • Deactivate rotating field monitoring (menu 5.68)!
E040	Pressure sensor fault	No response from sensor	Check the connection cable and sensor. Replace the defective component.
E040.2	Rainwater storage tank filling level sensor fault	No response from the rainwater storage tank filling level sensor	Check the connection cable and sensor. Replace the defective component.
E060	System overpressure	...	<ul style="list-style-type: none"> • Check threshold and correct if necessary (Menu 5.17). • ...
E061	System underpressure	...	<ul style="list-style-type: none"> • Check threshold and correct if necessary (Menu 5.18). • ...
E062	Low water level tank (dry-running protection) active	The water level in the tank has fallen below the minimum level.	<ul style="list-style-type: none"> • Check inlet and system parameters. • Check sensor/float switch is working correctly. Replace the defective component.
E066.1	High tank fill level	High fill level in the tank exceeded.	<ul style="list-style-type: none"> • Check inlet and system parameters. • Check sensor/float switch is working correctly. Replace the defective component.
E066.2	High water in rainwater storage tank	High water level in the rainwater storage tank exceeded.	<ul style="list-style-type: none"> • Check inlet and system parameters. • Check sensor/float switch is working correctly. Replace the defective component.
E066.4	Rainwater storage tank return**	A return in the rainwater storage tank from the overflow pipe was detected.	<ul style="list-style-type: none"> • Check overflow connection. • Check that the float switch is working correctly, replace the defective component.
E066.5	Tank overflow	Overflow level in the tank exceeded.	<ul style="list-style-type: none"> • Check inlet and system parameters. • Check sensor/float switch is working correctly. Replace the defective component.
E068	Priority off	Extern off active	<ul style="list-style-type: none"> • Extern off active was defined as an alarm in Menu 5.39. • Check the contact connection according to the connection diagram. Replace defective components.
E080.x	Pump fault**	<ul style="list-style-type: none"> • No pump connected. • Motor current monitoring not set (potentiometer is at "0"). • No feedback from the corresponding contactor. • Thermal motor monitoring (bimetallic sensor) triggered. • Motor current monitoring triggered. 	<ul style="list-style-type: none"> • Connect pump or deactivate minimum current monitoring (menu 5.69)! • Set the motor current monitoring to the pump's motor current. • Check functionality of pump. • Check that the motor has sufficient cooling. • Check the set motor current and correct if necessary. • Contact customer service.
E153	Automatic mode deactivated	Automatic mode was manually set to fresh water or rainwater utilisation in Menu 5.01.	Check Menu 5.01; set back to automatic mode if necessary.

Key:

**"x" = represents the pump to which the fault shown applies.

** Fault must be **manually** acknowledged.

11.6 Further steps for troubleshooting

If the points listed here do not rectify the fault, please contact customer service. Costs may be incurred if other services are used. For more details, please contact customer service.

12 Disposal**12.1 Information on the collection of used electrical and electronic products**

Proper disposal and appropriate recycling of this product avoids environmental damage and risks to personal health.



NOTICE

Disposal in domestic waste is prohibited!

In the European Union this symbol may be included on the product, the packaging or the accompanying documentation. It means that the electrical and electronic products in question must not be disposed of along with domestic waste.

Please note the following points to ensure proper handling, recycling and disposal of the used products in question:

- Hand over these products at designated, certified collection points only.
- Observe the locally applicable regulations!

Please consult your local municipality, the nearest waste disposal site, or the dealer who sold the product to you for information on proper disposal. Further recycling information at <http://www.wilo-recycling.com>.

13 Appendix

13.1 System impedances



NOTICE

Maximum switching frequency per hour

The connected motor determines the maximum switching frequency per hour.

- Note the technical data of the connected motor.
- Do not exceed the maximum switching frequency of the motor.



NOTICE

- Depending on the system impedance and the maximum connections/hour of the connected consumers, voltage fluctuations and/or drops may occur.
- When using shielded cables, attach the shielding to the earth rail on one side of the control device.
- Always have connection carried out by a qualified electrician.
- Observe the installation and operating instructions for the connected pumps and signal transmitters.

3~400 V, 2-pole, direct starting

Power in kW	System impedance in ohms	Connections/h
0.37	2.629	6 ... 30
0.55	1.573	6 ... 30
0.75	0.950	6 ... 18
0.75	0.944	24
0.75	0.850	30
1.1	0.628	6 ... 12
1.1	0.582	18
1.1	0.508	24
1.1	0.458	30
1.5	0.515	6 ... 12
1.5	0.431	18
1.5	0.377	24
1.5	0.339	30
2.2	0.321	6
2.2	0.257	12
2.2	0.212	18

3~400 V, 2-pole, direct starting		
Power in kW	System impedance in ohms	Connections/h
2.2	0.186	24
2.2	0.167	30
3.0	0.204	6
3.0	0.148	12
3.0	0.122	18
3.0	0.107	24
4.0	0.130	6
4.0	0.094	12
4.0	0.077	18
5.5	0.115	6
5.5	0.083	12
5.5	0.069	18

13.2 Overview of the symbols



Standby:
Symbol lights up: The switchgear is switched on and ready for operation.
Symbol flashing: Follow-up time of base-load pump is active



Value input not possible:
1. Input disabled
2. The accessed menu only displays values.



Pressure-boosting pumps ready for operation/de-activated:
Symbol lights up: Pump is available and ready for operation.
Symbol flashing: Pump is deactivated.



Pressure-boosting pumps working/fault:
Symbol lights up: Pump is in operation.
Symbol flashing: Pump fault



A pump has been set as the standby pump.



Fresh water utilisation active
3-way valve actuated



Underpressure detection threshold not reached



Overpressure detection threshold not reached



Control mode: Constant pressure control p-c



Low water monitoring (dry-running protection) active



“Extern OFF” Input active: All pumps switched off



There is at least one current (unacknowledged) error message.



The device communicates using a field bus system.



High water level reached



Rainwater utilisation active
3-way valve in default position/not actuated

13.3 Overview of terminal diagrams

1	2	3	4	5	6	7	8	9	10	11	12	13	14	15	16	17	18		
19	20	21	22	23	24	25	26	27	28	29	30	31	32	33	34	35	36		
37	38	39	40	41	42	43	44	45	46	47	48	49	50	51	52	53	54		

13.4 ModBus: Data types

Data type	Description
INT16	Integer in the range from -32768 to 32767. The number range actually used for a data point may vary.
UINT16	Unsigned integers in the range from 0 to 65535. The number range actually used for a data point may vary.
ENUM	Is a list. Only one of the values listed in the parameters can be set.
BOOL	A Boolean value is a parameter with exactly two states (0 – false and 1 – true). Generally, all values greater than zero are classified as true.
BITMAP*	Is an array of 16 Boolean values (bits). Values are indexed from 0 to 15. The number read from or written to the register is the sum of all bits with the value 1 multiplied by 2 to the power of its index. <ul style="list-style-type: none"> • Bit 0: $2^0 = 1$ • Bit 1: $2^1 = 2$ • Bit 2: $2^2 = 4$ • Bit 3: $2^3 = 8$ • Bit 4: $2^4 = 16$ • Bit 5: $2^5 = 32$ • Bit 6: $2^6 = 64$ • Bit 7: $2^7 = 128$ • Bit 8: $2^8 = 256$ • Bit 9: $2^9 = 512$ • Bit 10: $2^{10} = 1024$ • Bit 11: $2^{11} = 2048$ • Bit 12: $2^{12} = 4096$ • Bit 13: $2^{13} = 8192$ • Bit 14: $2^{14} = 16384$ • Bit 15: $2^{15} = 32768$
BITMAP32	Is an array of 32 Boolean values (bits). Please check Bitmap for the calculation details.

* Example for clarification:

Bit 3, 6, 8, and 15 are 1. All others are 0. The sum is then $2^3+2^6+2^8+2^{15} = 8+64+256+32768 = 33096$.

It is also possible to do the calculation the other way round. Based on the bit with the highest index, check whether the read number is greater than/equal to the power of two. If this is the case, bit 1 is set and the power of two is deducted from the number. Then the check with the bit with the next lower index and the recently calculated residual number is repeated until bit 0 is obtained or the residual number is zero.

Example for clarification: The read number is 1416. Bit 15 will be 0, since $1416 < 32768$. Bits 14 to 11 will also be 0. Bit 10 will be 1, since $1416 > 1024$. The remainder will be $1416-1024=392$. Bit 9 will be 0, since $392 < 512$. Bit 8 will be 1, since $392 > 256$. The remainder will be $392-256=136$. Bit 7 will be 1, since $136 > 128$. The remainder will be $136-128=8$. Bits 6 to 4 will be 0. Bit 3 will be 1, since $8 = 8$. The remainder will be 0. The remaining bits 2 to 0 will thus all be 0.

13.5 ModBus: Parameter overview

Holding register (protocol)	Name	Data type	Scaling and unit	Elements	Access*
40001 (0)	Communication profile version	UINT16	0.001		R
40002 (1)	Wink service	BOOL			RW
40003 (2)	Type of switchgear	ENUM		8. EC 9. ECe	R
40014 (13)	BusCommandTimer	ENUM		0. – 1. Off 2. Set 3. Active 4. Reset 5. Manual	RW
40015 (14)	Drives on/off	BOOL			RW
40025 (24)	Control mode	ENUM		21. Automatic mode 22. Fresh water utilisation 23. Rainwater utilisation	R
40026 (25)	Actual value	INT16	0.1 bar		R

Holding register (protocol)	Name	Data type	Scaling and unit	Elements	Access*
40027 (26)	Current setpoint	INT16	0.1 bar		R
40041 (40)	Pump mode 1	ENUM		0. Off 1. Manual 2. Auto	RW
40042 (41)	Pump mode 2	ENUM		0. Off 1. Manual 2. Auto	RW
40062 (61)	General status	BITMAP		0: SBM 1: SSM 8: EBM pump 1 9: EBM pump 2	R
40068 (67)	Setpoint 1	UINT16	0.1 bar		RW
40074 (73)	Application	ENUM		8. Rain	R
40122 (121)	Rainwater system status	BITMAP		0: SBM 1: SSM 6: Valve 1 actuated 7: Valve 2 actuated 12: Rainwater storage tank overflow 13: Rainwater storage tank dry run	R
40130 (129)	Valve mode 1	ENUM		0. Rain 1. Fresh 2. Auto	RW
40139 – 40140 (138 – 139)	Fault status	BITMAP32		0: Sensor fault 1: Overpressure 2: Underpressure 4: Dry running 5: Pump 1 error 6: Pump 2 error 15: High water 16: Overriding Off 20: Mains supply 25: Sensor error 2	R
40141 (140)	Acknowledge	BOOL			W
40142 (141)	Alarm history index	UINT16	1		RW
40143 (142)	Fault number alarm history	UINT16	0.1		R
40199 (198)	Filling level sensor 1	UINT16	1 cm	Rainwater storage tank	R
40380 (379)	Valve modus 2	ENUM		0. Rain 1. Fresh 2. Auto	RW
40381 – 40382 (380 – 381)	Rainwater error status	BITMAP32		1: Return in rainwater storage tank 4: Focus on rainwater utilisation 5: Focus on fresh water utilisation 6: Tank overflow 7: Fill level alarm	R
40383 (382)	Water volume of rainwater storage tank	UINT16	%		R

Legend

* R = read access only, RW = read and write access, W = write access

13.6 Connection of feeding pump(s)

If the negative suction head of the self-priming pumps is too high (length between rainwater storage tank and system too great, pipe section too small, swan neck, etc.), a feeding pump can be installed in the rainwater storage tank. The feeding pump is attached to a BE-WP switchgear. The BE-WP switchgear starts and stops the feeding pump.



NOTICE

If two rainwater storage tank pumps are connected, the failure of one rainwater storage tank pump directly results in a switchover to fresh water replenishment.

Electrical connection (1x BE-WP)

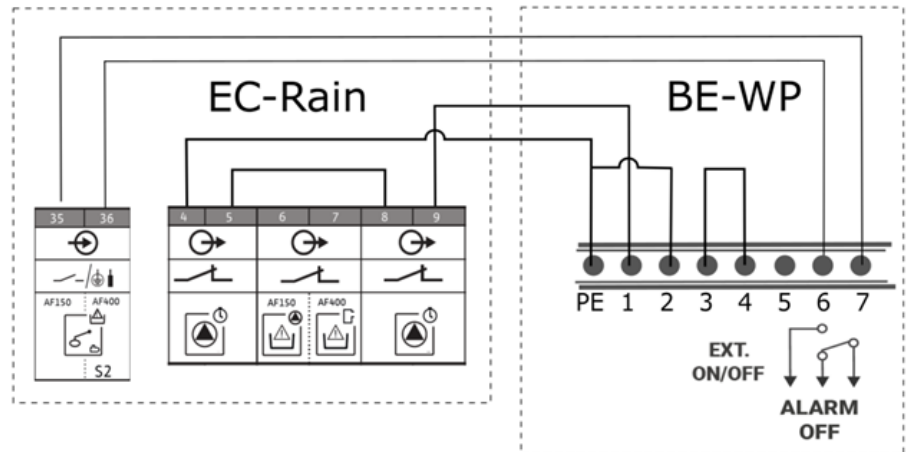

- Connect the switchgears together with a type H07RN-F cable or similar.
- Connect terminal 4 (EC-Rain switchgear) with the PE terminal (BE-WP switchgear).
- Connect terminals 5 and 8 (EC-Rain switchgear).
- Connect terminal 9 (EC-Rain switchgear) with terminal 1 (BE-WP switchgear).
- Connect the PE terminal and terminal 2 (BE-WP switchgear).
- Connect terminals 3 and 4 (BE-WP switchgear).
- Connect terminal 35 (EC-Rain switchgear) with terminal 7 (BE-WP switchgear).
- Connect terminal 36 (EC-Rain switchgear) with terminal 6 (BE-WP switchgear).
- Connect the BE-WP switchgear to the power supply; see the installation and operating instructions for the BE-WP switchgear.
- Make the settings for the power supply of the feeding pump in the BE-WP switchgear (single- or three-phase; 230 V or 400 V); see the installation and operating instructions for the BE-WP switchgear.

Electrical connection (2x BE-WP)

EC-Rain

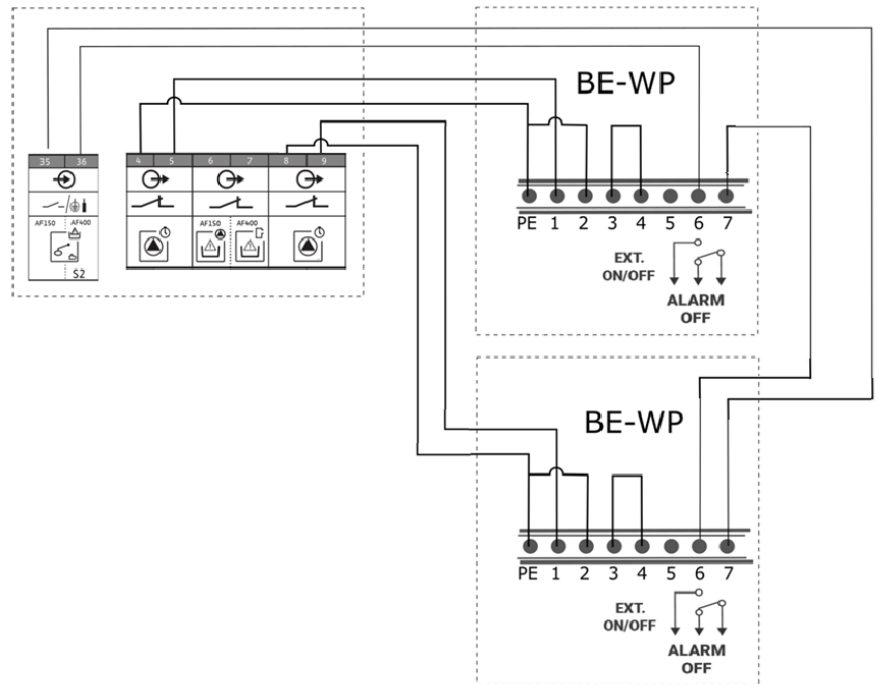



- Connect the switchgears together with a type H07RN-F cable or similar.
- Connect terminal 4 (EC-Rain switchgear) with PE terminal (1st BE-WP switchgear).
- Connect terminal 5 (EC-Rain switchgear) with terminal 1 (1st BE-WP switchgear).
- Connect terminal 8 (EC-Rain switchgear) with PE terminal (2nd BE-WP switchgear).
- Connect terminal 9 (EC-Rain switchgear) with terminal 1 (2nd BE-WP switchgear).
- Connect the PE terminal and terminal 2 (1st and 2nd BE-WP switchgear).
- Connect terminals 3 and 4 (1st and 2nd BE-WP switchgear).
- Connect terminal 35 (EC-Rain switchgear) with terminal 7 (2nd BE-WP switchgear).
- Connect terminal 36 (EC-Rain switchgear) with terminal 6 (1st BE-WP switchgear).
- Connect terminal 7 (1st BE-WP switchgear) with terminal 6 (2nd BE-WP switchgear).
- Connect the BE-WP switchgears to the power supply; see the installation and operating instructions for the BE-WP switchgear.
- Make the settings for the power supply of the feeding pump in the BE-WP switchgears (single- or three-phase; 230 V or 400 V); see the installation and operating instructions for the BE-WP switchgear.

Settings on the EC-Rain switchgear

- Menu 5.10: Set parameter to “both”.
- Menu 5.76: To start the feeding pump before one of the system’s pumps is started, set the delay time to “-2sec”.

Settings on the BE-WP switchgear

- I_{max} : Set the current of the connected feeding pump (see the rating plate on the feeding pump).
- I_{min} : set to 0.5 A.
-  : set to “Off”.
-  : set to “Off”.
- Call up the Pro mode:
 - Select “Set” and push button.
 - Select “dAtA” and push button.
 - Push “Easy” and hold button down for 8 seconds. “Pro” is shown on the display.



- Changing the pump mode: Call up the “P.dir” menu and set to fill mode “In”. Attention: Only this entry may be changed.

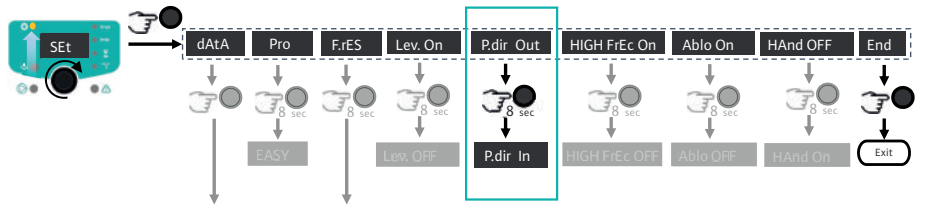







wilo



Local contact at
www.wilo.com/contact

Pioneering for You

WILO SE
Wilopark 1
44263 Dortmund
Germany
T +49 (0)231 4102-0
T +49 (0)231 4102-7363
wilo@wilo.com
www.wilo.com