

Pioneering for You

wilo

Isar BOOST5



en Installation and operating instructions



Isar BOOST5
<http://qr.wilo.com/617>

Valable uniquement pour la France:



Points de collecte sur www.quefairemesdechets.fr
Privilégiez la réparation ou le don de votre appareil !

Table of contents

1 Safety	4
1.1 About these instructions	4
1.2 Copyright	4
1.3 Subject to change.....	4
1.4 Exclusion from warranty and liability.....	4
1.5 Identification of safety instructions	4
1.6 Personnel qualifications.....	4
1.7 Electrical work	4
1.8 Installation /Dismantling.....	4
1.9 Maintenance tasks.....	5
2 Product description	5
2.1 Description.....	5
2.2 Description of control panel.....	5
2.3 Type key	6
2.4 Technical data	6
2.5 Dimensions	6
2.6 Scope of delivery.....	6
3 Application/use	6
3.1 Intended use.....	6
3.2 Improper use.....	7
4 Transportation and storage	7
4.1 Delivery.....	7
4.2 Transport.....	7
4.3 Storage	7
5 Installation and electrical connection	7
5.1 Installation location.....	7
5.2 Hydraulic connection	7
5.3 Electrical connection	8
6 Commissioning	8
6.1 Filling the diaphragm expansion tank.....	8
6.2 Operating modes	9
6.3 Setting operating pressure.....	10
6.4 Alarm codes	10
7 Maintenance	12
7.1 Diaphragm expansion tank maintenance.....	12
8 Faults, causes and remedies	12
9 Spare parts	13
10 Disposal	13
10.1 Information on the collection of used electrical and electronic products.....	13

1 Safety

1.1 About these instructions

These instructions form part of the product. Compliance with the instructions is essential for correct handling and use:

- Read the instructions carefully before all activities.
- Keep the instructions in an accessible place at all times.
- Pass the instructions on to a subsequent owner.
- Observe all product specifications.
- Observe the markings on the product.

The language of the original operating instructions is German. All other languages for these instructions are translations of the original operating instructions.

Failure to observe the instructions will result in danger to persons or damage to property. The manufacturer is not liable for damage caused by:

- Improper use.
- Incorrect operation.

1.2 Copyright

WILO SE © 2025

The reproduction, distribution and utilisation of this document in addition to communication of its contents to others without express consent is prohibited. Offenders will be held liable for payment of damages. All rights reserved.

1.3 Subject to change

Wilo shall reserve the right to change the listed data without notice and shall not be liable for technical inaccuracies and/or omissions. The illustrations used may differ from the original and are intended as an exemplary representation of the product.

1.4 Exclusion from warranty and liability

Wilo shall specifically not assume any warranty or liability in the following cases:

- Inadequate configuration due to inadequate or incorrect instructions by the operator or the client
- Non-compliance with these instructions
- Improper use
- Incorrect storage or transport
- Incorrect installation or dismantling
- Insufficient maintenance
- Unauthorised repairs
- Inadequate construction site
- Chemical, electrical or electrochemical influences
- Wear

1.5 Identification of safety instructions

In these installation and operating instructions, safety instructions are displayed as follows:

- Danger to persons: Safety instructions are **preceded by a corresponding symbol** and are shaded in grey.
- Damage to property: Safety instructions start with a signal word and are displayed **without** a symbol.

Signal words

- **DANGER!**
Failure to follow the instructions will result in serious injuries or death!
- **WARNING!**
Failure to follow the instructions can lead to (serious) injury!
- **CAUTION!**
Failure to follow the instructions can lead to potentially irreparable property damage.
- **NOTICE!**
Useful information on handling the product

Symbols

These instructions use the following symbols:



General danger symbol



Danger caused by electric voltage



Notes

Follow all information that appears on the product and ensure that it remains permanently legible:

- Warning and hazard notices
- Rating plate
- Direction of rotation arrow/symbol for direction of flow
- Labelling of connections

1.6 Personnel qualifications

Personnel must:

- be instructed about locally applicable regulations governing accident prevention,
- have read and understood the installation and operating instructions.

Staff must have the following qualifications:

- Electrical work: Electrical work must be performed by a qualified electrician.
- Installation/dismantling work: The installation/dismantling must be carried out by a qualified technician who is trained in the use of the necessary tools and fixation materials.
- The product must be operated by persons who have been instructed on how the complete system functions.
- Maintenance tasks: The technician must be familiar with the use of operating fluids and their disposal.

Definition of “qualified electrician”

A qualified electrician is a person with appropriate technical education, knowledge and experience who can identify **and** prevent electrical hazards.

The operator must confirm and ensure the field of authority, the competence and the monitoring of the personnel. If the personnel do not possess the necessary knowledge, they must be trained and instructed. If required, this can be carried out by the product manufacturer at the operator's request.

The product must not be operated by persons (including children) with limited physical, sensory or mental capabilities unless they have been trained in the use of the product by a person responsible for their safety.

Children must be supervised to ensure that they do not play with the product.

1.7 Electrical work

- Electrical work must be performed by a qualified electrician.
- Nationally applicable guidelines, standards and regulations as well as specifications issued by the local energy supply companies for connection to the local power supply system must be observed.
- Before commencing work, disconnect the product from the mains and secure it against being switched on again.
- The connection must be secured by means of a residual-current device (RCD).
- The product must be earthed.
- Have defective cables replaced immediately by a qualified electrician.

1.8 Installation / Dismantling

- Wear protective equipment:
 - Safety shoes
 - Safety gloves for protection against cuts

- Safety helmet (when using lifting equipment)
- Locally applicable laws and regulations on work safety and accident prevention must be complied with.
- Disconnect the device from the mains and secure it against being switched on again without authorisation.
- All rotating parts must be at a standstill.
- Close the gate valve in the inlet and in the pressure pipe.
- Provide adequate aeration in enclosed spaces.
- Make sure that there is no risk of explosion when carrying out any type of welding work or work with electrical devices.

1.9 Maintenance tasks

- Wear protective equipment:
 - Sealed safety glasses
 - Safety shoes
 - Safety gloves for protection against cuts
- Locally applicable laws and regulations on work safety and accident prevention must be complied with.
- The procedure described in the installation and operating instructions for shutting down the product/unit must be strictly observed.
- Only original parts from the manufacturer may be used for maintenance and repairs. The use of any non-original parts releases the manufacturer from any liability.
- Disconnect the device from the mains and secure it against being switched on again without authorisation.
- All rotating parts must be at a standstill.
- Close the gate valve in the inlet and in the pressure pipe.
- Store tools at the designated locations.
- After completing work, reattach all safety and monitoring devices and check that they function properly.

2 Product description

2.1 Description

- Compact, quiet and high-performance pump system.
- Electrical system with intelligent and intuitive product control.
 - The system pressure is kept constant by adjusting the pump speed according to usage.
 - The product controls the hydraulic and electrical operating parameters and protects against malfunctions.

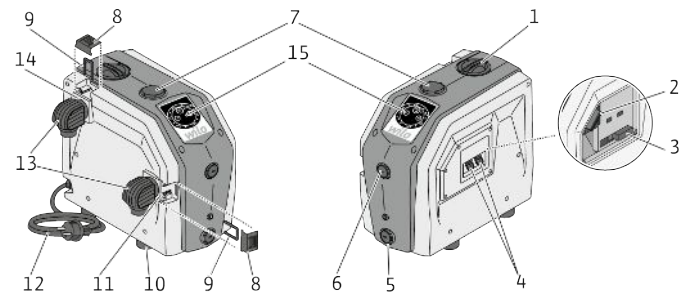

Fig. 1: Product overview

1	Refill opening cap
2	Extension card
3	Fuse (12 A)
4	Input/Output cable entry
5	Drainage screw plug
6	Venting screw
7	Diaphragm expansion tank closure
8	Discharge/suction port cover
9	Discharge / suction port handle grip
10	Height-adjustable feet (vibration dampening)
11	Suction port
12	Mains cable
13	Rotatable connection elbow
14	Discharge port
15	Control panel

2.2 Description of control panel

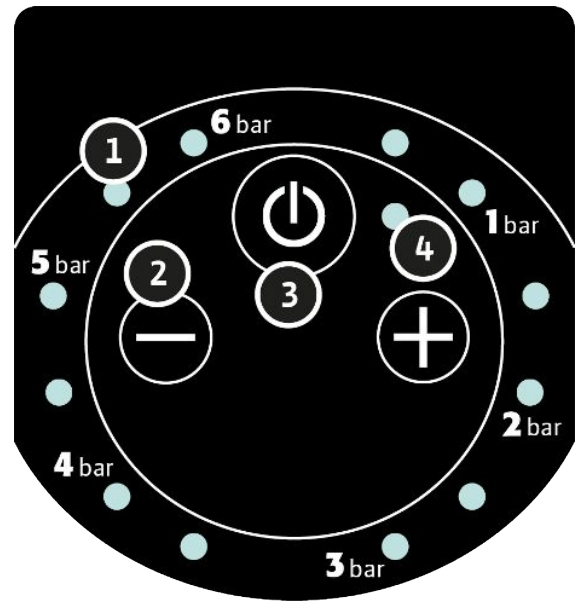
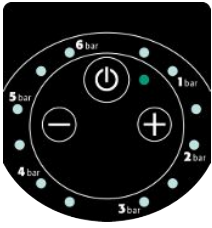

Fig. 2: Control panel

1	LEDs: "Operating status" <ul style="list-style-type: none"> • Pressure setting display • Operation • Fault or alarm
2	Operating buttons: "+" and "-"
3	Operating button: "On/Off"
4	LED: "System status" (green and red)

2.2.1 Description of operating modes



System ready for operation

- System is switched on and not in operation.
- “Operating status” LEDs are switched off.
- “System status” LED lights up green permanently.

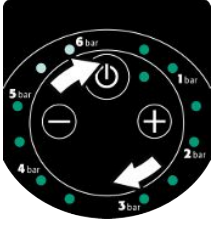

System in operation

- System is switched on and in operation.
- “Operating status” LEDs run in a cycle.
- “System status” LED lights up green permanently.

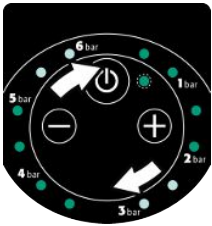

System switches itself off

- System shuts down.
- “Operating status” LEDs run in a cycle.
- “System status” LED flashes green.

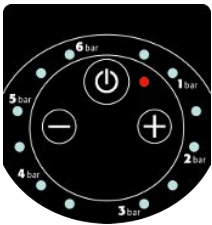

System fault/alarm

- Unit is switched on but not ready for operation.
- “Operating status” LEDs are switched off.
- “System status” LED lights up red permanently.

2.3 Type key

Example:	Wilo-Isar BOOST5-E-3-2G
Wilo	Brand name
Isar	Pressure-boosting system
BOOST	Household use
5	Integrated pump control
E	Electronically controlled
3 or 5	Rated volume flow in m ³ /h
2G	2nd generation

2.4 Technical data

	Wilo-Isar BOOST5-E-3-2G	Wilo-Isar BOOST5-E-5-2G
General		
Dimensions (LxWxH)	390x276x343 mm	390x276x343 mm
Net weight (±10%)	15 kg	16 kg
Permitted fluid	Clean water (max. chlorine content 0.2 mg/L)	Clean water (max. chlorine content 0.2 mg/L)
Noise level	55 dB(A) sound pressure at 1 m during normal operation	55 dB(A) sound pressure at 1 m during normal operation
Connection on the discharge side	G1"	G1"
Connection on the suction side	G1"	G1"
Pressure		

	Wilo-Isar BOOST5-E-3-2G	Wilo-Isar BOOST5-E-5-2G
Max. operating pressure	5 bar	6 bar
Max. suction pressure	4 bar (H+)	4 bar (H+)
Max. volume flow	See rating plate	See rating plate
Max. delivery head	See rating plate	See rating plate
Geodesic head suction	8 m (H-)	8 m (H-)
Start-up pressure	1 bar	1 bar
Temperature		
Fluid temperature	0 °C to +40 °C	0 °C to +40 °C
Ambient temperature	0 °C to +40 °C	0 °C to +40 °C
Electrical data		
Voltage	1~ 230 V alternating current	1~ 230 V alternating current
Frequency	50/60 Hz	50/60 Hz
Power consumption	See rating plate	See rating plate
Rated current	See rating plate	See rating plate
Alarm relay contact	Max. 0.3 A at 230 V alternating current / Max. 1 A at 30 V direct current	Max. 0.3 A at 230 V alternating current / Max. 1 A at 30 V direct current
IP rating	IPX4	IPX4
Motor protection	Protection fuse max. 12 A	Protection fuse max. 12 A
Power supply cable	1.5 m	1.5 m

2.5 Dimensions

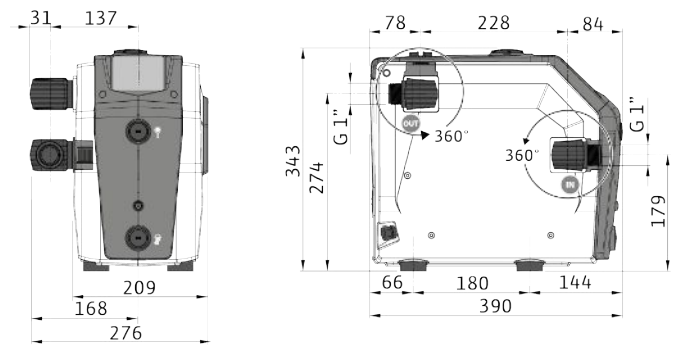

Fig. 3: Dimensions

2.6 Scope of delivery

- Pressure-boosting system
- 2 G1" hydraulic connections
- Handle grip for discharge ports
- Gaskets
- Installation and operating instructions

3 Application/use

3.1 Intended use

Wilo-Isar BOOST5 is an automatic pressure-boosting system with variable speed function including:

- a highly efficient self-priming electric pump,
- a diaphragm expansion tank,
- Pressure and volume flow sensors,
- a non-return valve in the suction port.

The pressure-boosting system is designed for increasing the pressure of clean water in residential buildings and for irrigation, sprinkling in agriculture.

Water is supplied from wells, springs, tanks or the municipal water supply network.



NOTICE

- Observe local regulations for all drinking water applications.

3.2 Improper use

Only for DE:

The product must not be used for drinking water applications within Germany. Connection to the municipal water supply network is not permitted.

4 Transportation and storage

4.1 Delivery

- After delivery, check product and packaging for defects (damage, completeness).
- The transport company or the manufacturer must be notified of any defects the day the shipment is received, and the damage noted on the freight documentation.

Claims cannot be asserted if the notification of defects takes place at a later date.

4.2 Transport

CAUTION

Property damage due to wet packaging!

Wet packaging may tear. If unprotected, the product may fall on the ground and be irreparably damaged.

- Carefully lift wet packaging and replace it immediately.

1. Only transport the product in the packaging provided.
2. If the outer packaging is damaged or no longer present, apply suitable protection from humidity and dirt.
3. Remove the outer packaging only once the system is on site.

4.3 Storage

CAUTION

Property damage due to improper storage!

Moisture and certain temperatures damage the product.

- Protect the product against moisture and mechanical damage.
- Avoid temperatures outside the range of $-10\text{ }^{\circ}\text{C}$ to $+60\text{ }^{\circ}\text{C}$.

5 Installation and electrical connection

5.1 Installation location

- The installation site must be dry, well-ventilated and protected from frost.
- Observe ambient temperatures, see technical data.
- Select installation location according to product dimensions.
- Connections must be freely accessible.

- Avoid vibrations or mechanical loads from the connected piping.

5.2 Hydraulic connection



WARNING

Risk of injury due to improper installation.

- Installation should only be carried out by qualified personnel.
- Comply with accident prevention regulations.
- Observe local regulations.

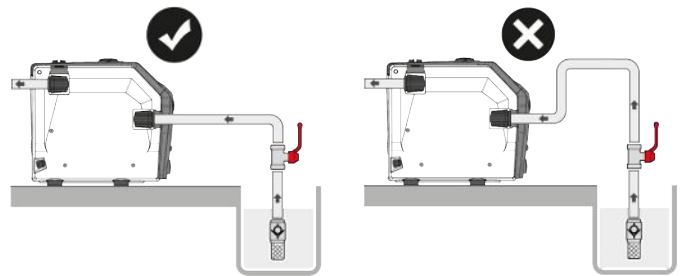

Fig. 4: Hydraulic lines

- Avoid elbows and goosenecks in the suction lines.
- Suction line must be pressure resistant.
- If automatic connectors are employed, use a seal (applied inside). To prevent air intake, the automatic connectors have to be airtight.
- Check the suction line from the strainer to the pump and the check valve for leaks.

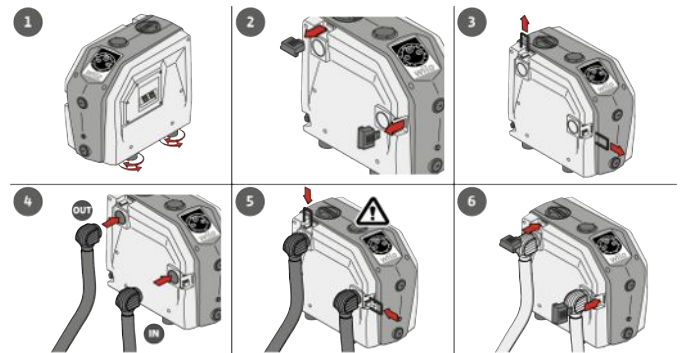

Fig. 5: Hydraulic connection

- ✓ Use a pressure-resistant connection pipe.
 - ✓ Avoid excessive bends in the connection pipes.
1. Align the product horizontally using the adjustable feet.
 2. Remove the covers on the holders of the discharge and suction ports.
 3. Remove the handle grip on the discharge and suction ports.
 4. Connect the pressure-resistant connection pipes to the hydraulic connections (included in scope of delivery). Inside diameter of connection pipe: G1"
 5. Insert suction and discharge port with gasket.
 6. Fit the handle grip on the discharge and suction ports.
 7. Fit the covers on the holders of the discharge and suction ports.

5.3 Electrical connection



DANGER

Danger of death due to electrical current!

Improper electrical connection can lead to electric shock.

- Have electrical work carried out by a qualified electrician.
- Comply with accident prevention regulations.
- Observe local regulations.

- Install residual-current device (30 mA, class A).
- Check earthing connection for proper installation.
- Ensure that the power supply corresponds to the specifications on the rating plate.

5.3.1 Connecting the extension card



DANGER

Risk of fatal injury due to electrical current!

- Disconnect the plug from the power supply before carrying out any work.
- Have electrical work carried out by a qualified electrician.
- Observe local regulations.

CAUTION

Property damage due to improper installation!

- Device connected to the extension card must only be operated with separated extra-low voltage (separated extra-low voltage, SELV).

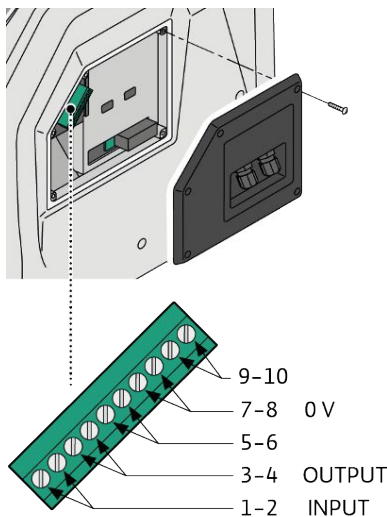

Fig. 6: Extension card connections

1. Remove fastening screws on the cover.
2. To access the terminal strip of the extension card, partially remove the cover.

Terminal		Description
1-2	Input	Level message. Bypass in case of a missing signal

Terminal		Description
3-4	Output	Alarm signal. Max 0.3 A at 230 V alternating current/1 A at 30 V direct current
5-6	RS 485	Communication MASTER /SLAVE
7-8	0 V	Not connected
9-10	SLAVE	If bridged, the inverter becomes a SLAVE

6 Commissioning

6.1 Filling the diaphragm expansion tank

CAUTION

Property damage due to improper installation!

The integrated diaphragm expansion tank is prefilled ex works with nitrogen to a pressure of 1.5 bar. The maximum filling pressure is 4 bar.

- For filling, use nitrogen or air.
- Fill the diaphragm expansion tank at a system pressure of zero.
- Fill the diaphragm expansion tank according to the table.
- After each change of operating pressure, the filling pressure of the diaphragm expansion tank must be adjusted.

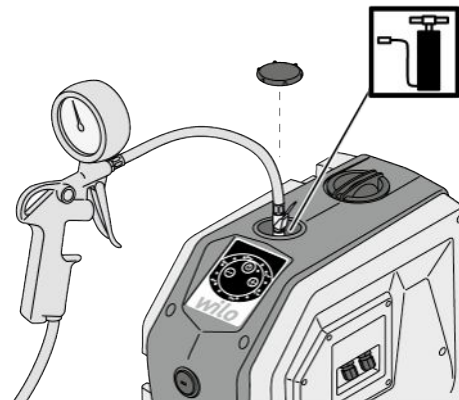

Fig. 7: Filling the diaphragm expansion tank

Desired operating pressure (bar)	Filling pressure (bar) of diaphragm expansion tank
1.0	0.5
1.5	1.0
2.0	1.0
2.5	1.5
3.0	1.5
3.5	2.0
4.0	2.5
4.5	3.0
5.0	3.5
5.5	4.0
6.0	4.0

- ✓ Compressor or pump with manometer at hand.

1. Close the gate valve (Fig. 7 – Item 1, 2) at the suction and discharge sides.
2. Remove the screw at the diaphragm expansion tank closure.
3. Connect the compressor or air pump (hand pump) to the closure of the diaphragm expansion tank.
4. Fill the diaphragm expansion tank until the desired and set operating pressure is reached.



NOTICE

If necessary, install an additional diaphragm expansion tank on the discharge side to avoid pressure peaks.

6.2 Operating modes

The product can be operated in suction mode (pump above the water level) and in load mode (pump under the water level).

CAUTION

Property damage due to dry run!

If the pump runs dry, the mechanical seals will be damaged.

- Fill the pump with water and vent it before commissioning.

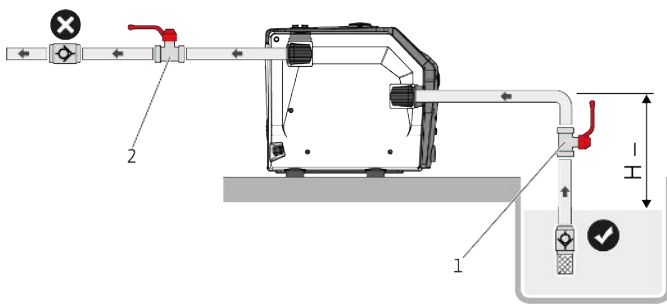

Fig. 8: Suction mode

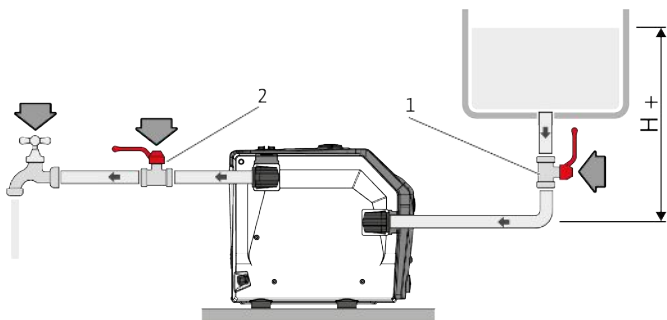

Fig. 9: Load operation

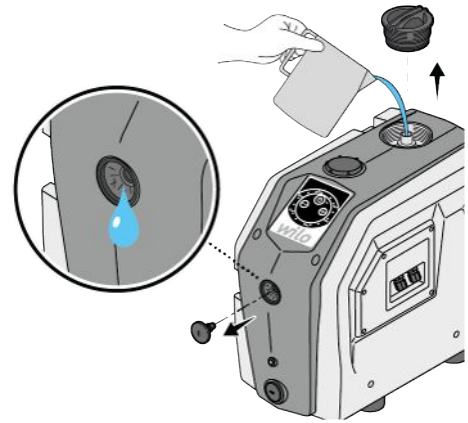

Fig. 10: Filling

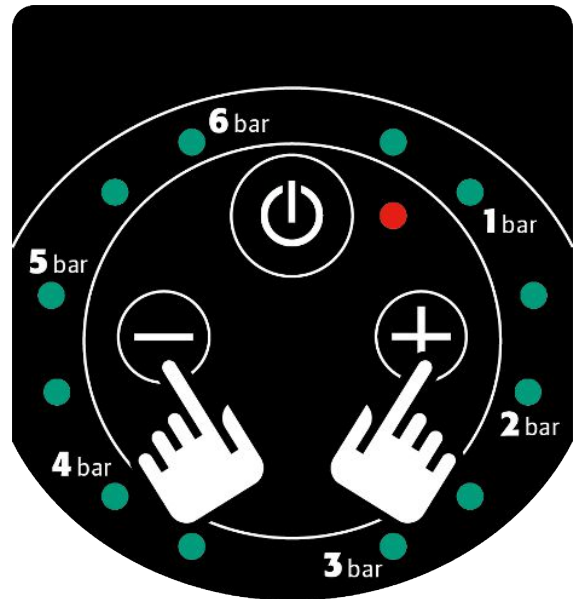

Fig. 11: Operating buttons + and -

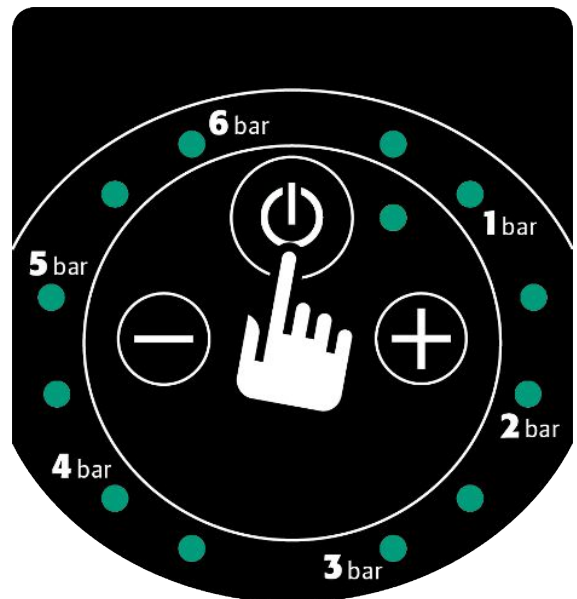

Fig. 12: Operating button On/Off

- Remove the refill opening cap and the venting screw.
- Fill the product with water (approx. 1.5 l) until the water comes out of the aeration opening (Fig. 9).
- Put the refill opening cap and the venting screw back on.
- Open the gate valve (Item 1, 2).
- Connect the mains plug to the power supply.

Load operation

1. If the product is installed in load mode (Fig. 8), press the “On/Off” operating button once (Fig. 11).
⇒ Pump starts.

Suction mode

1. If the product is installed in suction mode (Fig. 7), press the “+” and “-” operating buttons simultaneously for 5 seconds (Fig. 10).
⇒ The product switches to suction mode.
2. Press the “On/Off” operating button on the control panel (Fig. 11).
⇒ Suction takes a maximum of 5 minutes. During the process, the LEDs flash. Suction is stopped after 5 minutes or if the suction is completed. The LEDs no longer flash.
3. If the pump does not self-prime, repeat the procedure.

6.3 Setting operating pressure

The “operating status” LEDs indicate the desired operating pressure.

The operating pressure can be set between 1 bar and 6 bar.

- Indicate operating pressure: Press operating button “+”.
- Adjust the operating pressure by 0.5 bar at a time: Press operating buttons “-” or “+”.

Example:

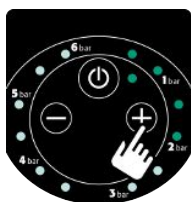

- Press operating button “+”.
- Operating pressure is displayed (2 bar).

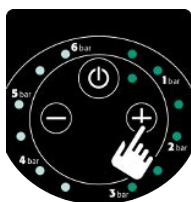

- Increase the operating pressure to 3 bar by pressing the operating button “+” twice (0.5 bar + 0.5 bar).
- The “operating status” LEDs indicate the current operating pressure (3 bar).

6.4 Alarm codes

LED in range 1-6 flashes green + LED flashes red

Alarm 1

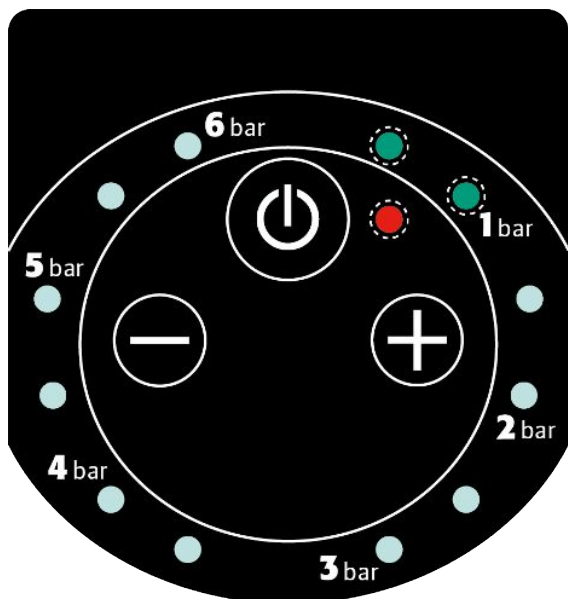

Low water	<p>If there is low water on the suction side for more than 7 seconds, the alarm is displayed.</p> <ul style="list-style-type: none"> • Check the water supply on the suction side. • Fill pump. <p>The product restarts automatically after 1 min, 15 min, 30 min, 1 hr, etc.</p>
-----------	-----------------------------------------------------------------------------------------------------------------------------------------------------------------------------------------------------------------------------------------------------------------------------------------------------------

Alarm 2

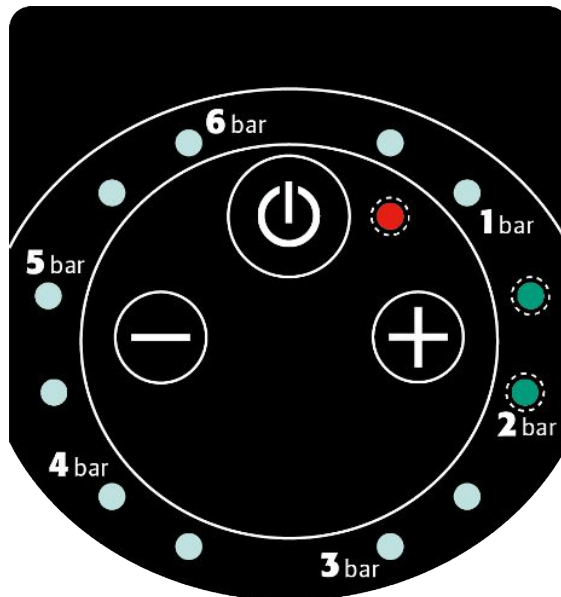

The pump does not reach the set pressure.	<ul style="list-style-type: none"> • Contact customer service.
-------------------------------------------	-------------------------------------------------------------------------------

Alarm 4

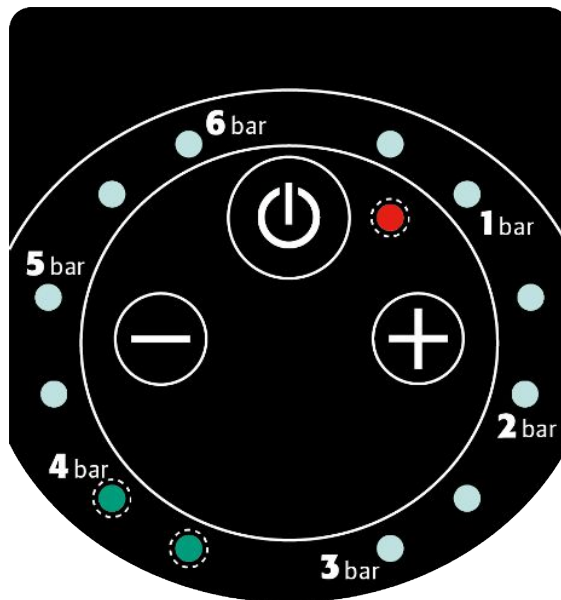

Outlet pressure below 0.2 bar (damaged pipe).	<ul style="list-style-type: none"> • Eliminate the cause. • To reset the alarm, switch the product off and back on with the “On/Off” operating button (Fig. 2, Item 3). • Check why pressure was reset to zero.
-----------------------------------------------	--------------------------------------------------------------------------------------------------------------------------------------------------------------------------------------------------------------------------------------------------

Alarm 5

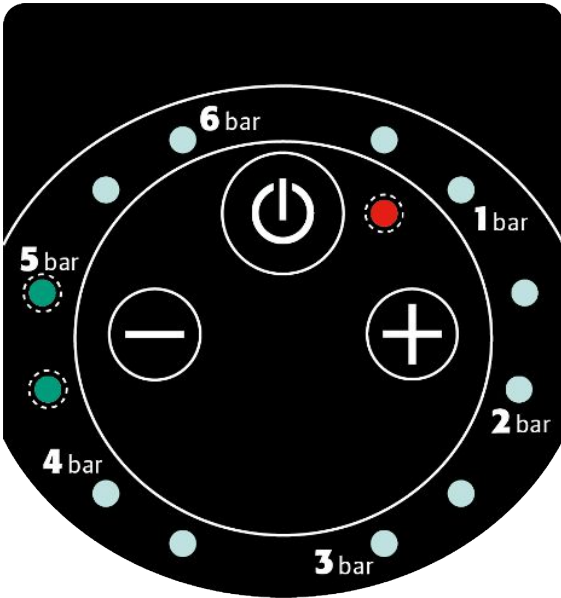

Supply voltage too low.

- Ensure a power supply of 230 V ±10%.

Alarm 6

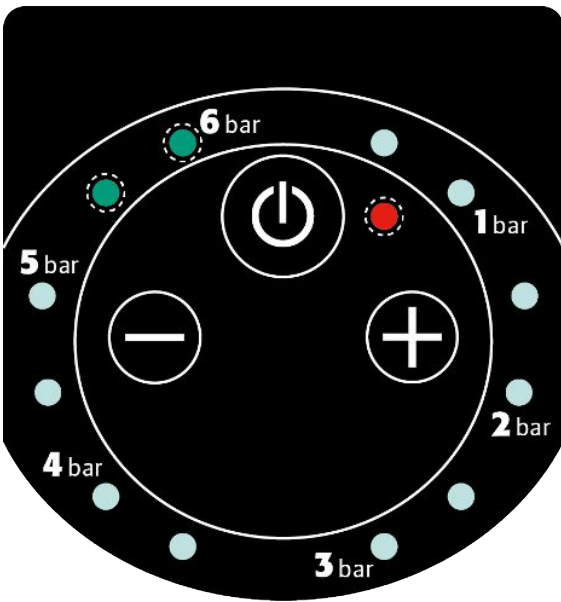

Switch-off signal from the outside

Example

Low water: LED 1 flashes green + red LED flashes

LED in area 1-6 lights up green + LED flashes red

Alarm 1

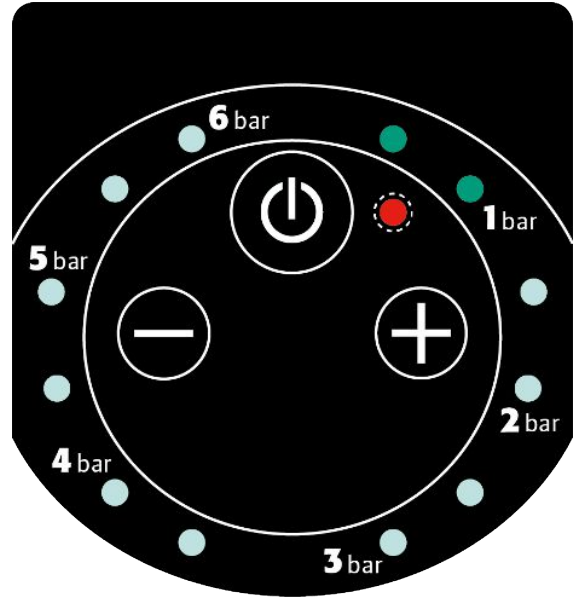

Short-circuit

- Switch off unit.
- Contact customer service.
- To reset the alarm, switch the product off and back on with the "On/Off" operating button (Fig. 2, Item 3).

Alarm 2

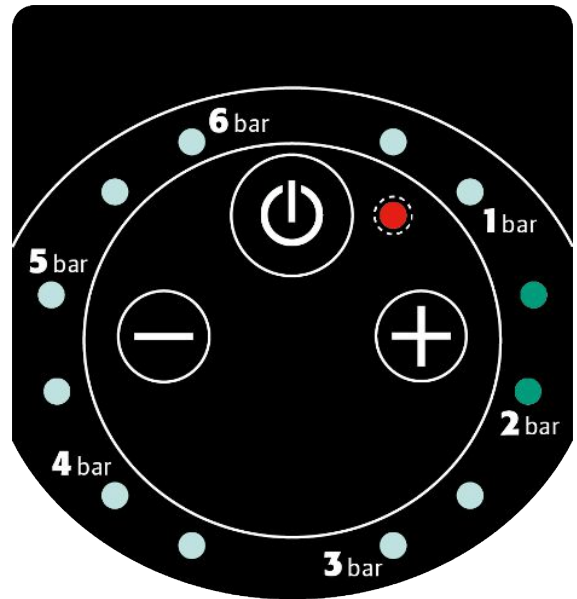

Overcurrent

- Current consumption exceeds the permissible tolerance.
- To reset the alarm, switch the product off and back on with the "On/Off" operating button (Fig. 2, Item 3).
 - If the alarm is still displayed, contact customer service.

Alarm 3

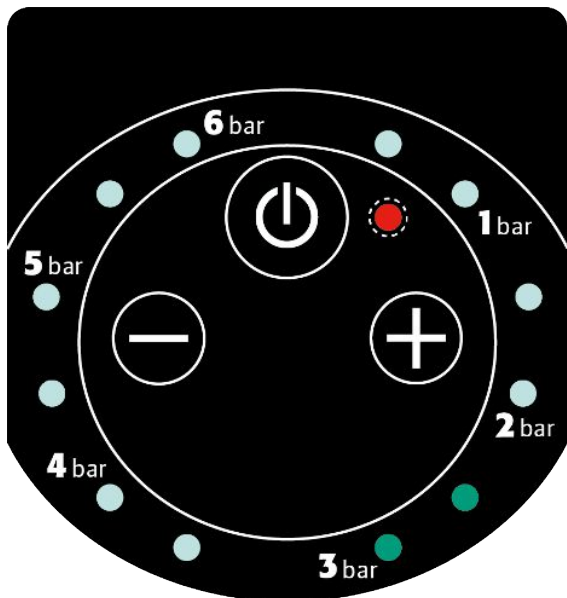

Module temperature too high

- Check the temperature of the fluid.
- If the fluid temperature exceeds 40 °C, contact customer service.

If the temperature drops below the alarm threshold, the product is automatically reset.

Alarm 5

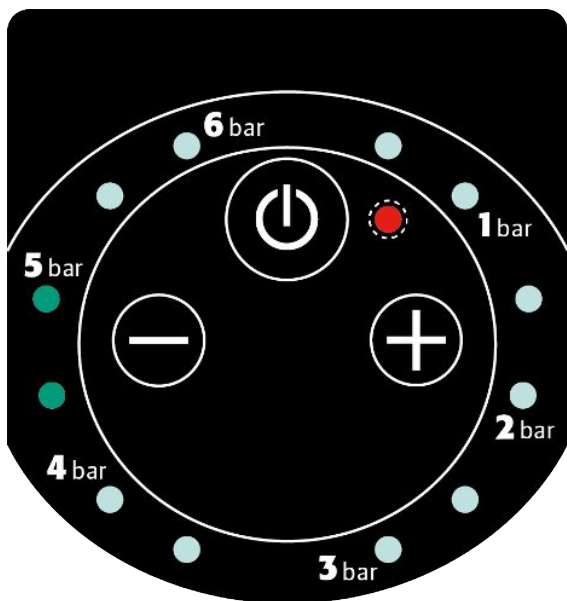

Pressure sensor signal fault

- Contact customer service.

Example

Short-circuit: LED 1 lights up green + red LED flashes

7 Maintenance

7.1 Diaphragm expansion tank maintenance

CAUTION

Property damage due to improper maintenance!

The product will be damaged if the diaphragm expansion tank is set improperly.

- at least once a year (Wilo recommends: every 6 months): Check the filling pressure of the diaphragm expansion tank and fill if necessary.
- Adjust the filling pressure of the diaphragm expansion tank every time the operating pressure changes.

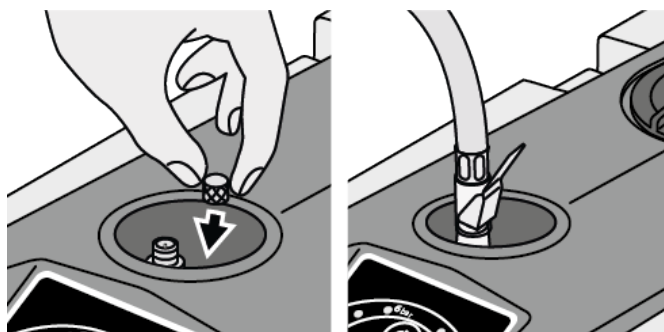

To provide for improved access to the valve seal, the valve of the diaphragm expansion tank is offset by design. The extra space at the side serves to make installation of the pressure hose easier and to store the sealing cap.

8 Faults, causes and remedies



DANGER

Risk of fatal injury due to electrical current!

- Disconnect the plug from the power supply before carrying out any work.
- Have electrical work carried out by a qualified electrician.
- Observe local regulations.



WARNING

Risk of injury due to improper repair!

- Only allow repairs to be carried out by qualified personnel.

Fault	LED signal	Remedy
Control panel does not light up.	LEDs do not light up.	Check supply voltage and proper condition of the residual-current device.
Pump does not start.	System status LED flashes red.	See "Alarm codes".
	System status LED lights up green permanently.	System pressure does not drop below the set operating pressure.

Fault	LED signal	Remedy
Low water	System status LED flashes red.	Check that the suction is supplied with water.
	Operating status LEDs flash green.	Ensure that the suction is not clogged. Fill the pump and allow the suction to work.
Short-circuit	System status LED flashes red.	Ensure that the system is not blocked:
	Operating status LEDs light up permanently green.	<ul style="list-style-type: none"> Open the plug on the back of the motor and rotate the shaft.
		Check that the cable, plug and socket are undamaged and that there are no leakage currents.
Voltage too low	System status LED flashes red.	Voltage is lower than 15% below the value indicated on the rating plate. Ensure that the voltage is within the limit values $\pm 15\%$.
	Operating status LEDs flash green in section "5".	

9 Spare parts

Spare parts are ordered via customer service. To avoid return queries and incorrect orders, the article number and production date must always be supplied. **Subject to change without prior notice!**

10 Disposal

10.1 Information on the collection of used electrical and electronic products

Proper disposal and appropriate recycling of this product avoids environmental damage and risks to personal health.



NOTICE

Disposal in domestic waste is prohibited!

In the European Union this symbol may be included on the product, the packaging or the accompanying documentation. It means that the electrical and electronic products in question must not be disposed of along with domestic waste.

Please note the following points to ensure proper handling, recycling and disposal of the used products in question:

- Hand over these products at designated, certified collection points only.
- Observe the locally applicable regulations!

Please consult your local municipality, the nearest waste disposal site, or the dealer who sold the product to you for information on proper disposal. Further recycling information at <http://www.wilo-recycling.com>.

Subject to change without prior notice!





wilo



Local contact at
www.wilo.com/contact

Pioneering for You

WILO SE
Wilopark 1
44263 Dortmund
Germany
T +49 (0)231 4102-0
T +49 (0)231 4102-7363
wilo@wilo.com
www.wilo.com